



TVBI TRASMITTENTI E SPECIALI

1939 - XVII

I

F. I. V. R. E.
FABBRICA ITALIANA VALVOLE RADIO ELETTRICHE
Società Anonima

SEDE SOCIALE E AMMINISTRAZIONE: MILANO - Corso Venezia, 13

STABILIMENTO I: PAVIA - Via Fabio Filzi, 1

STABILIMENTO II: FIRENZE - Via Pancialichi, 30

DATI TECNICI DI ALCUNI TUBI
ELETTRONICI TRASMITTENTI
PRODOTTI DALLO
STABILIMENTO II° "F.I.V.R.E.",
DI FIRENZE.

TUBI ELETTRONICI

TIPO	ACCENSIONE		1) Catodo	2) μ	$\mu_{1,2}$	S mA/V	3) CAPACITÀ INTERELETTRODICA			Dimensioni fig.	Placca Volt mass. c. c.	Scher- mo Volt mass. c. c.
	Volt	Amp.					Cgp	Cgf	Cpf			
3 A 50	10	1.05	f. o.	10	—	3.5	5	9	5	1	1000	—
3 B 250	12.5	6.5	f. w.	25	—	1.2	7.5	6	1	2	4000	—
3 C 20	10.3	2.5	f. w.	29	—	0.9*	5.2	7.5	2	3	1000	—
3 C 70	10	4.5	f. w.	31	—	1.7	3	9	3.5	4	1600	—
3 C 300	12.5	6.5	f. wt.	22	—	1.6	4	5	1.2	5	3000	—
4 C 15	4	1.15	f. o.	70	8.5	1.7*	0.03	12.5	8.5	6	600	250
5 C 10	4	0.65	f. o.	200	4.5	2*	0.03	12	9	7	400	200
5 C 15	4	1.05	f. o.	230	4.8	2.6	0.02	13.5	10	8	600	200
5 C 100	12	2.7	f. wt.	500	2.8	1.75	0.03	15	18	9 a	1500	500
5 C 100 P	9	3	f. wt.	500	2.8	1.75	0.03	28	18	9 b	1500	500
5 C 500	12	10	f. wt.	200	3.5	5*	0.15	35	28	10	3000	600
4 C 100	12	3	f. wt.	200	4.6	3.2	0.08	16.5	17.5	9 a	1500	500
4 C 500	12	10	f. wt.	500	5.5	10*	0.15	35	28	10	3000	600

TRASMITTENTI "FIVRE,"

Dissi- paz. placca mass. Watt	Dissip. scher. mass. w	4) Servizio	Placca Volt c. c.	Soppres. Volt c.c.	Scher- mo Volt c. c.	Griglia Volt c. c.	Placca mAmp. c. c.	Poten- za eccitaz. Watt	Poten- za utile Watt	OSSERVAZIONI
75	—	B bf. C tg. C tf.	1000 1000 750	— — —	— — —	- 100 - 150 - 130	250 120 98	4 5 6	170 90 55	Rpp = 9300 Ω 5)
250	—	C tg. C tf.	4000 3000	— —	— —	- 320 - 360	100 70	8 12	300 160	
20	—	C tg. C tf.	1000 1000	— —	— —	- 125 - 150	45 30	3 4	30 22	* S a 20 mA
70	—	C tg. C tf.	1600 1400	— —	— —	- 135 - 170	65 50	4 6	75 45	
300	—	B bf. C tg. C tf.	3000 3000 2500	— — —	— — —	- 125 - 330 - 530	600 320 290	30 35 40	1200 700 500	Rpp = 11300 Ω Valvola adatta per freq. alte
18	4	C tg.	600	—	250	- 70	50	1.5	13	* S a 30 mA
10	3	C tg. C tf.	400 350	0 0	200 180	- 90 - 100	40 30	0.4 0.6	8.5 5	* S a 30 mA Modulare anche sullo schermo
15	3	C tg. C tf.	600 500	0 0	200 200	- 100 - 140	60 50	1 1	24 16.5	Modulare anche sullo schermo
100	25	C tg. C tf.	1500 1250	0 0	500 400	- 270 - 300	150 130	1.8 2.2	160 120	Modulare anche sullo schermo
400	60	B rf. C tg. C tf.	3000 3000 2500	0 0 0	600 600 400	- 180 - 330 - 360	250 400 280	3.5 3.5 4	260 900 560	Condizioni massime Modulare anche sullo schermo
100	20	C tg. C tf.	1500 1250	0 0	500 400	- 200 - 230	150 130	1 1.5	160 120	Tetrodo a fascio elettronico Modulare anche sullo schermo
400	60	B rf. C tg. C tf.	3000 3000 2500	0 0 0	600 600 400	- 110 - 180 - 150	250 400 280	2 2 3	260 900 560	Tetrodo a fascio elettronico Modulare anche sullo schermo

TUBI ELETTRONICI

(CORRISPONDENTI AI TIPI

TRASMETTENTI "FIVRE,,

R C A DI UGUALE DENOMINAZIONE)

TIPO	ACCENSIONE		Catodo	1)	2)	S mA/V	3) CAPACITÀ INTERELETTRODICA			Dimensioni fig.	Placca Volt mass. c. c.	Scher- mo Volt mass. c. c.	Dissip. Placca mass. W	4) Servizio	Placca Volt c. c.	Soppress. Volt c. c.	Scher- mo Volt c. c.	Griglia Volt c. c.	Placca mAmp. c. c.	Poten- za eccitaz. Watt	Poten- za utile Watt	OSSERVAZIONI
	Volt	Amp.		μ	μ_{1-2}		Cgp	Cgf	Cpf													
203 A	10	3.25	f. wt.	25	—	3.4	14.5	6.5	5.5	11	1250	—	100	B bf. C tg. C tf.	1250 1250 1000	— — —	— 45 - 125 - 135	320 170 150	11 8 4	260 160 100	Rpp = 9000 Ω 5)	
211	10	3.25	f. wt.	12	—	3.15	14.5	6	5.5	11	1250	—	100	B bf. C tg. C tf.	1250 1250 1000	— — —	- 100 - 200 - 260	320 170 150	8 8 14	260 160 100	Rpp = 9000 Ω	
805	10	3.25	f. wt.	variab. (circa 48)	—	4.2 *	6.5	8.5	10.5	12	1500	—	125	B bf. C tg. C tf.	1500 1500 1250	— — —	- 16 - 105 - 160	400 200 160	7 8.5 16	370 215 140	Rpp = 8200 Ω * S a 75 mA	
806	5	10	f. wt.	12.6	—	2	3.4	6.1	1.1	13	3000	—	150	B bf. C tg. C tf.	3000 3000 2500	— — —	- 240 - 600 - 600	330 195 195	10 20 32	660 450 390	Rpp = 21500 Ω	
807	6.3	0.9	c. o.	10	135	6 *	0.2	11	7	14	600	300	25	2.5 C tg. C tf.	600 475	0 0	250 225	- 50 - 50	100 83	0.2 0.1	37 24	Tetrodo a fascio elettronico Modulare anche sullo schermo * S a 75 mA
834	7.5	3.25	f. wt.	10.5	—	2	2.6	2.2	0.2	15	1250	—	50	C tg. C tf.	1250 1000	— —	- 225 - 310	90 90	4.5 6.5	75 58	Adatta per frequenze elevate	
845	10	3.25	f. wt.	5.3	—	2.5	13.5	6	6.5	11	1250	—	75	B bf.	1250	—	- 225	200	—	105	Rpp = 8800 Ω	
849	11	5	f. wt.	19	—	5.8 *	33.5	17	3	16	3000	—	400	B bf. B rf. C tg. C tf.	3000 2500 2500 2000	— — — —	- 155 - 125 - 250 - 300	520 210 300 300	16 12 8 14	1100 180 560 425	Rpp = 12800 Ω * S a 100 mA	

TUBI ELETTRONICI TRASMITTENTI

(CORRISPONDENTI AI TIPI

"FIVRE,, RAFFREDDATI AD ACQUA

RCA DI UGUALE DENOMINAZIONE)

TIPO	ACCENSIONE		Catodo	μ	S mA/V	CAPACITÀ INTERELETTRODICA			Dimensioni fig.	Placca Volt mass c. c.	Dissi- pazione placca mass. KW	Servizio	Placca Volt c. c.	Griglia Volt c. c.	Placca Amp. c. c.	Potenza eccitaz W	Potenza utile KW	OSSERVAZIONI
	Volt	Amp.				Cgp	Cgf	Cpf										
207	22	52	fw	20	5.7 *	27	18	2	22	15000	10	B bf. B rf. C tg. C tf.	12500 14000 12000 10000	- 575 - 650 1600 - 2000	2.8 1 1.67 0.75	400 0 235 185	22.5 4 15 6	Rpp = 10000 Ω * S a 750 mA
846	11	51	fw	40	2.15 *	9	6.5	1.5	23	7500	2.5	B rf. C tg. C tf.	7000 7000 6000	- 100 - 900 - 950	0.45 0.9 0.5	175 300 200	1 4.25 2.25	* S a 750 mA
858	22	52	fw	42	4.8 *	18	16	2	24	20000	20	B bf. B rf. C tg. C tf.	12000 18000 18000 12000	- 140 - 300 - 1200 1000	3.6 0.9 1.8 0.95	115 85 250 150	26.5 5.6 22.4 8	Rpp = 7200 Ω * S a 750 mA
892	22	60	fw	50	7 *	27	18	2	25	15000	10	B bf. B rf. C tg. C tf.	12500 14000 12000 10000	- 200 - 220 - 1600 - 1600	2.8 0.95 1.64 0.72	420 30 500 260	22 4 14 6	Rpp = 10000 Ω * S a 750 mA Il filamento è formato da due unità in se- rie che possono essere alimentate separa- tamente con fasi diverse e tensione di 11 V.

DIODI RADDRIZZATORI

A VAPORI DI MERCURIO

TIPO	ACCENSIONE		Corrente anodica c. c. Amp.	Cresta cor- rente an- odica Amp.	Cresta ten- sione in- versa V	Tempera- tura mer- curio con- densato C°	Dimen- sioni fig.	OSSERVAZIONI
	Volt	Amp.						
866 A 866 B	2.5	5	0.25	1	10.000	20° — 60°	17 18	<p>La caduta di tensione interna è in media di 12 Volt.</p> <p>Il filamento deve essere acceso almeno un minuto prima di dar tensione alla placca.</p> <p>Il mercurio deve essere condensato in basso, se non lo fosse tenere acceso il filamento 15 ÷ 30 minuti.</p>
869 A	5	18	2.5	10	20.000	15° — 50°	19	
872 A 872 G	5	7	1.25	5	10.000	20° — 60°	20 21	

SPIEGAZIONI

- 1) c. = catodo a riscaldamento indiretto
 f. = filamento a riscaldamento diretto
 o. = ad ossidi
 w. = in tungsteno puro
 wt. = in tungsteno toriato

$$2) \mu = \frac{\delta E_a}{\delta E_{g1}} \quad \mu_{1-2} = \frac{\delta E_{g2}}{\delta E_{g1}}$$

S = Conduttanza mutua: è misurata a 50 mA di corrente anodica, a meno che non sia diversamente indicato nelle osservazioni (*).

- 3) Per i triodi le capacità indicate sono quelle dirette.
 Per le valvole a griglia schermo, con o senza soppressore, C_{g-p} è misurata con valvola schermata esternamente (nella parte inferiore) o con virola metallica collegata a terra; C_{g-f} e C_{p-f} sono le capacità statiche d'entrata e d'uscita.

- 4) **B bf.** = Amplificatore classe B per bassa frequenza, modulatore.
 Per questo funzionamento i dati si riferiscono a due valvole montate in controfase.

B rf. = Amplificatore Classe B per radio frequenza modulata.
 La potenza d'eccitazione si riferisce alla cresta di modulazione.

C tg. = Amplificatore classe C, telegrafia.

C tf. = " " " telefonia con modulazione anodica, condizioni per la portante.

- 5) R_{pp} = Resistenza di carico fra placca e placca per **B bf.**

Quando si parla di modulazione ci si riferisce alle condizioni teoriche di m = 1 ed onda sinusoidale.

RAFFRONTO TRA I TUBI ELETTRONICI "FIVRE,"
E QUELLI DELLA CONCORRENZA

TIPO FIVRE	TIPI DELLA CONCORRENZA PERFETTAMENTE SOSTITUIBILI	TIPI DELLA CONCORRENZA SIMILI
3 A 50	Philips MC. 1/50	Telefunken RS 243, RS 237
3 B 250	Marconi T 250, Philips TA 4/250 S	
3 C 20	Telefunken RS 69, Philips W 69	
3 C 70	Telefunken RS 31, Philips W 31	
3 C 300	RCA 833
4 C 15	Philips W 15 S	
5 C 10	RCA 802
5 C 15	Philips PC 05/15	
5 C 100	{ RCA 803, Raytheon RK 28 Telefunken RS 337
5 C 100 P	Philips PC 1,5/100	
5 C 500	Telefunken RS 384	
4 C 100	*	RCA 813, Raytheon RK 48
4 C 500	*	

* I) due tetrodi a fascio elettronico possono essere praticamente montati su tutti gli apparecchi che abbiano il tipo corrispondente con soppressore (5 C 100, 5 C 500), purchè naturalmente detto soppressore sia collegato al catodo.

DIMENSIONI DEI TUBI TRASMITTENTI "FIVRE,,

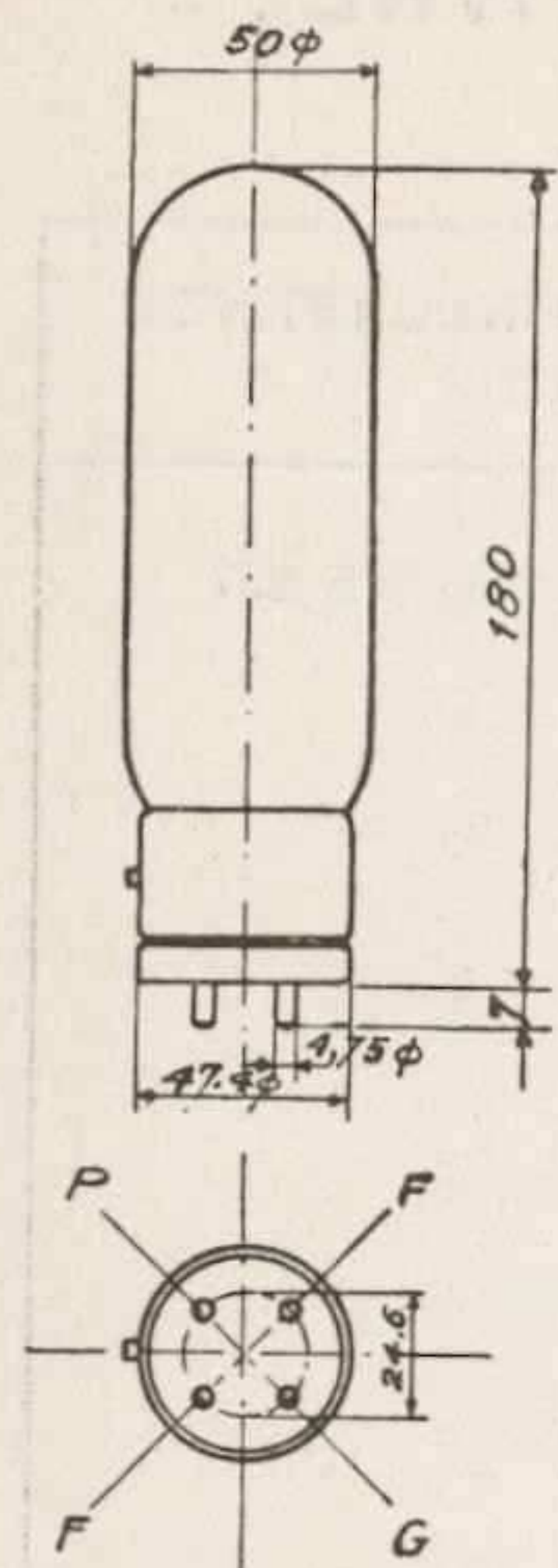

Fig. 1

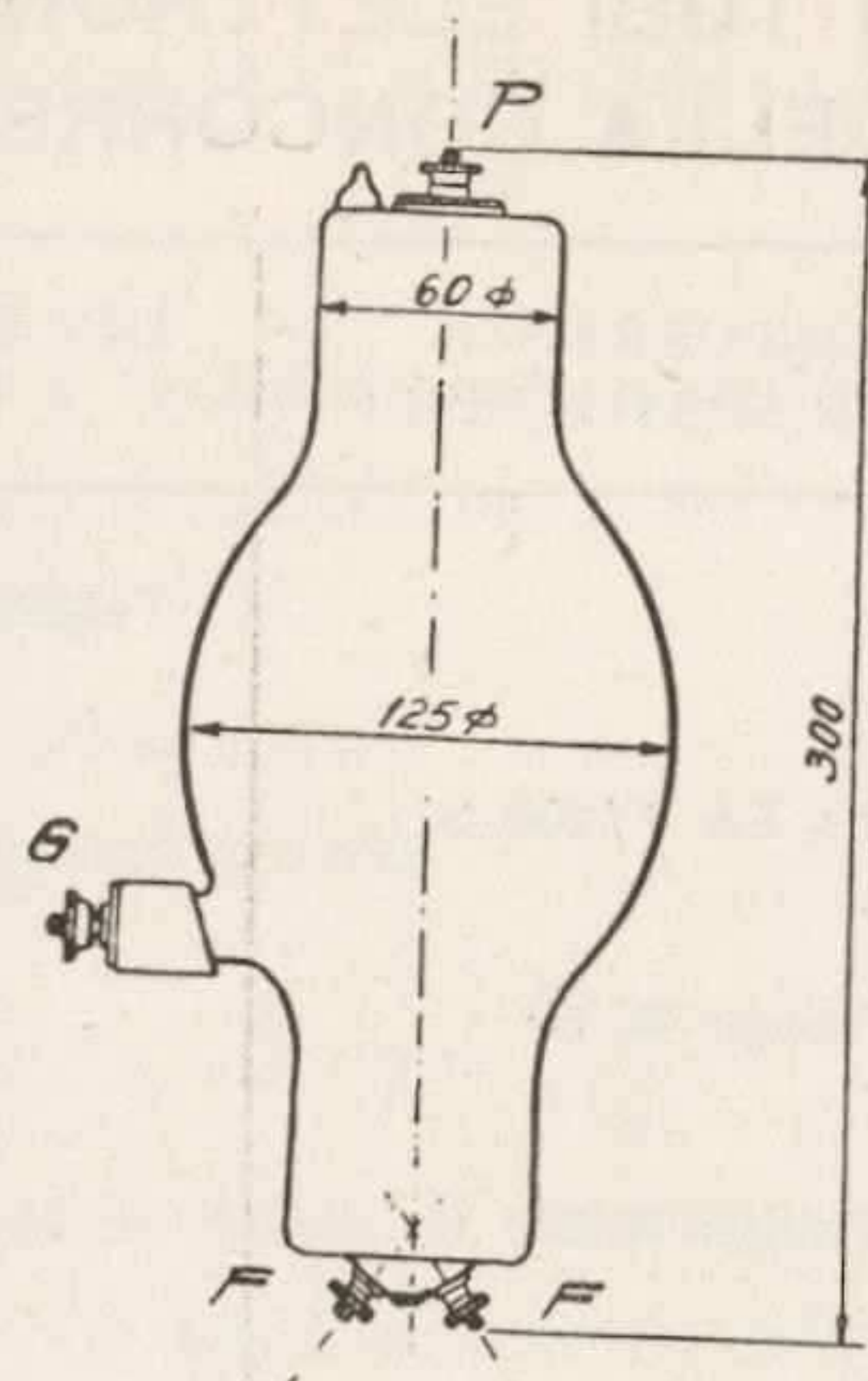

Fig. 2

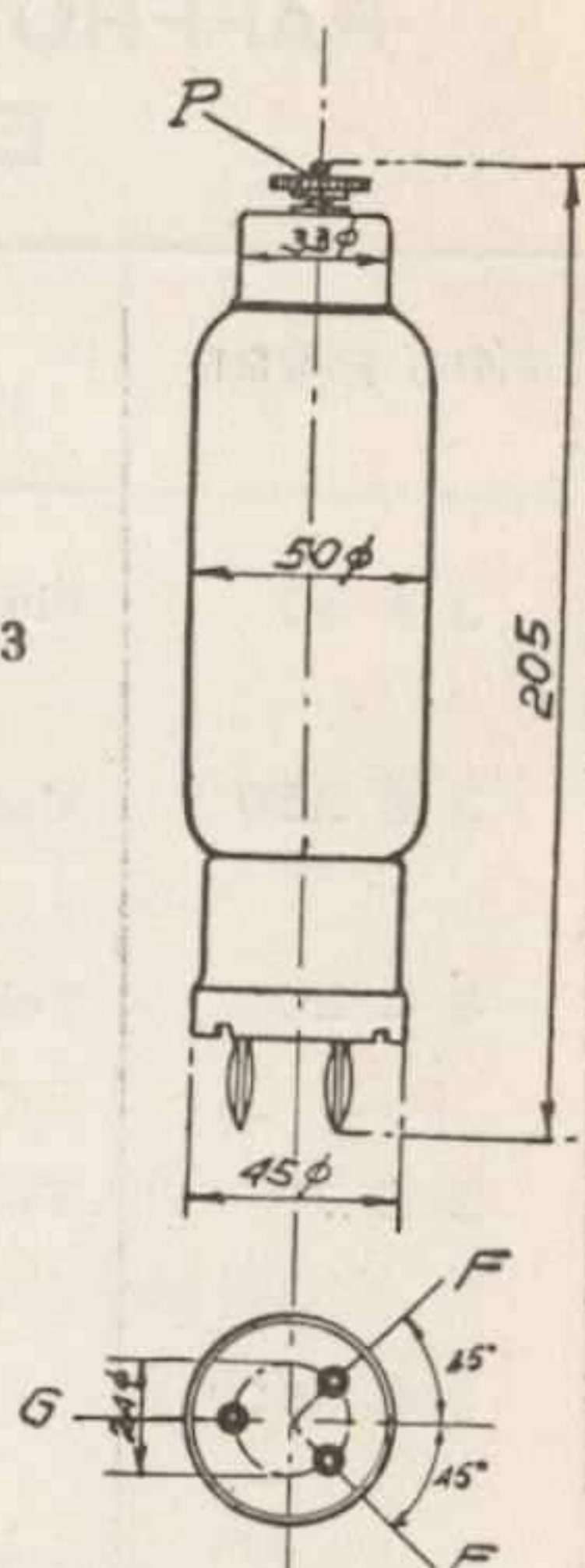

Fig. 3

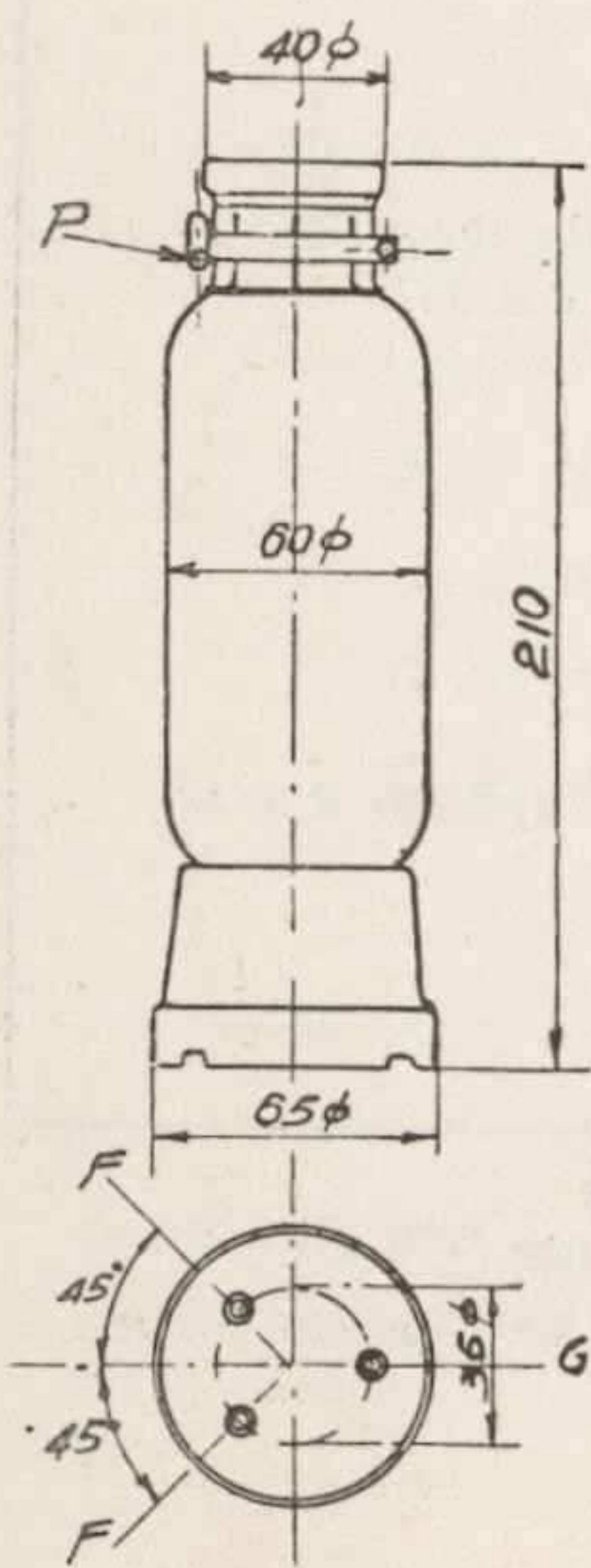

Fig. 4

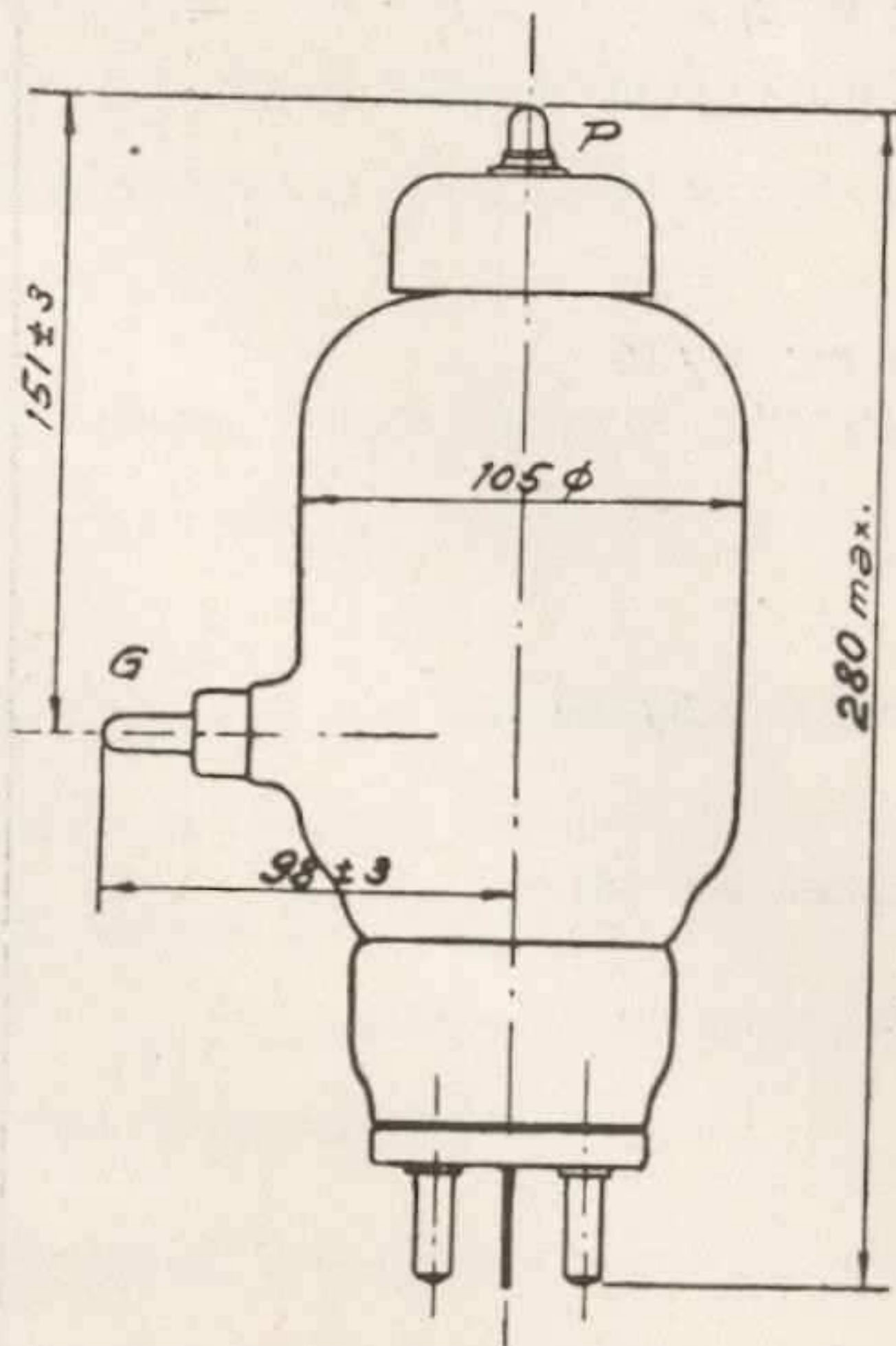

Fig. 5

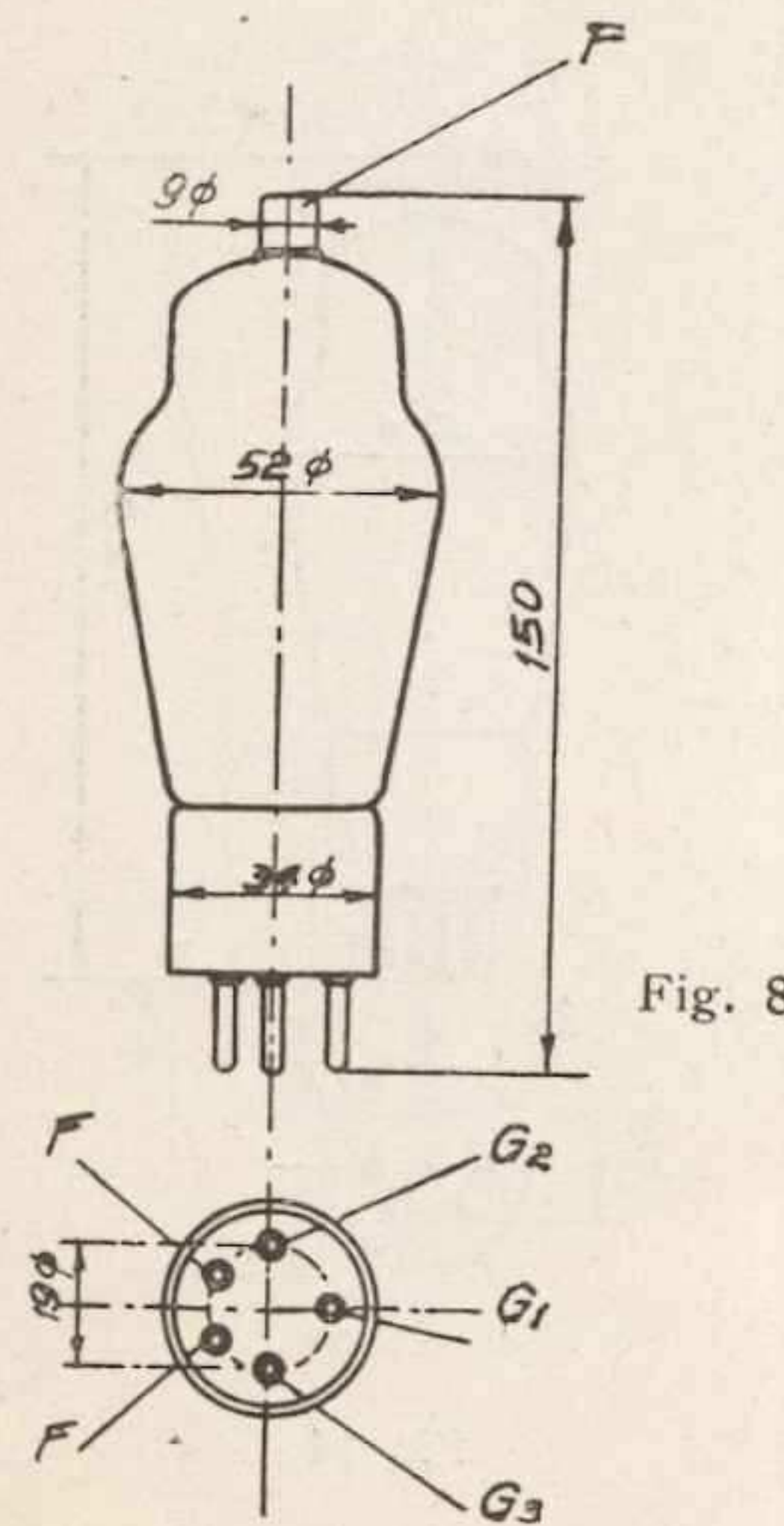
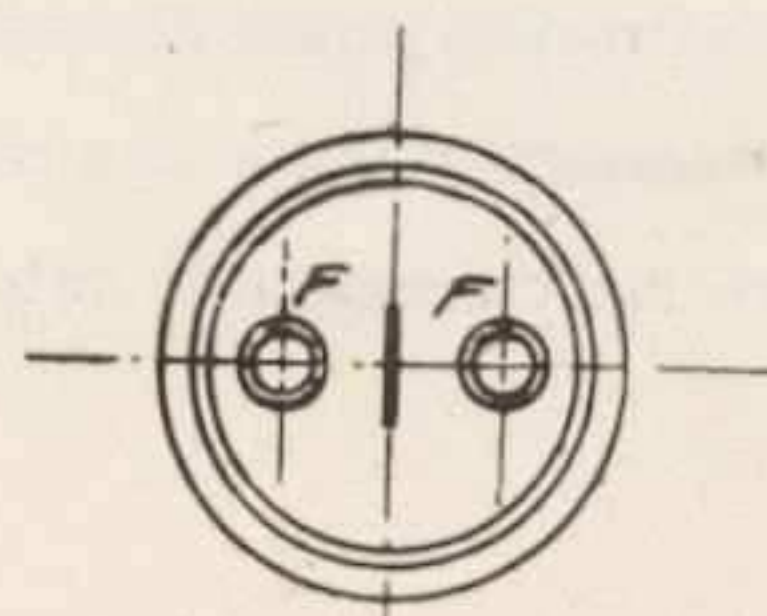

Fig. 8

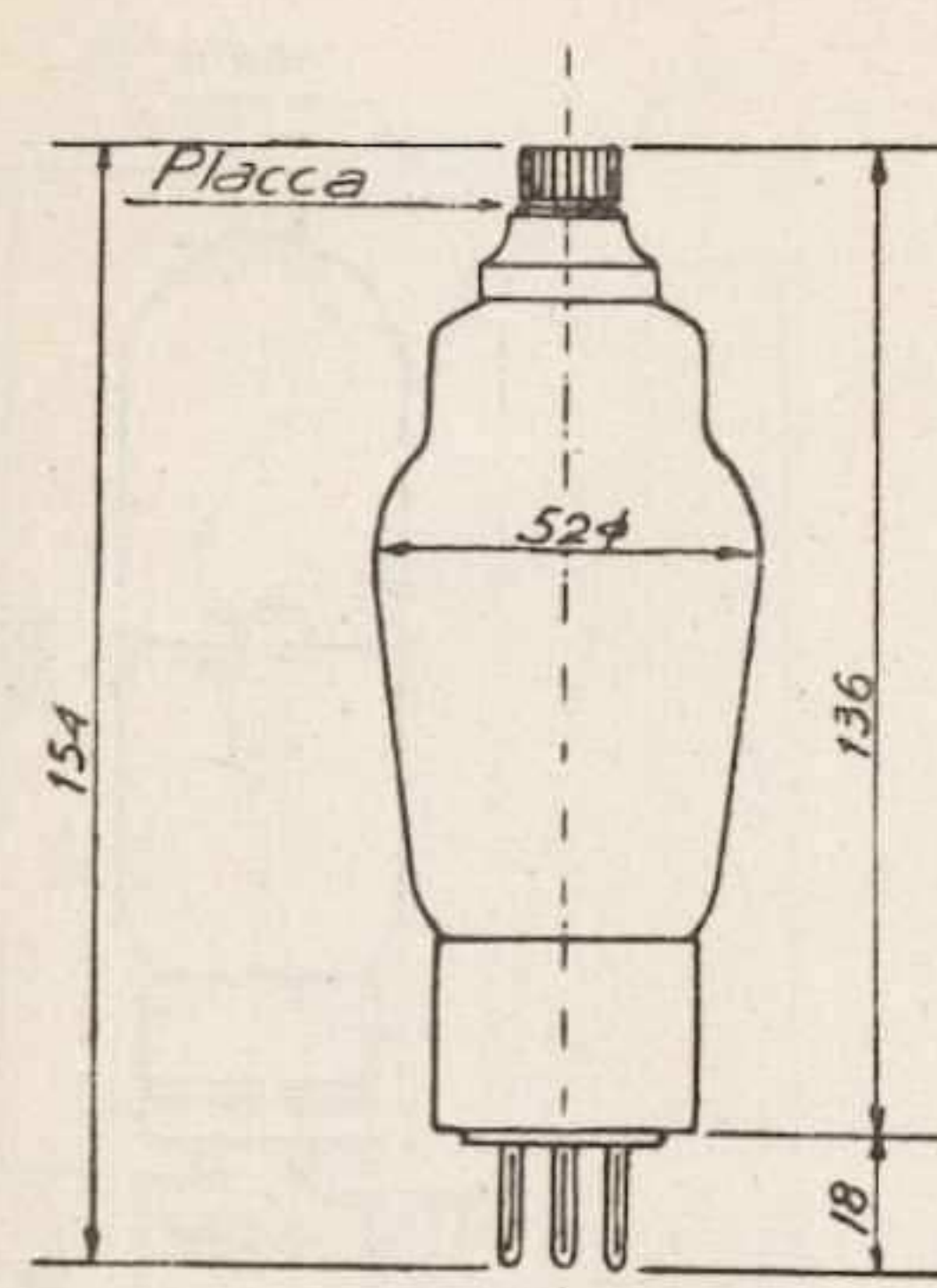

Fig. 6

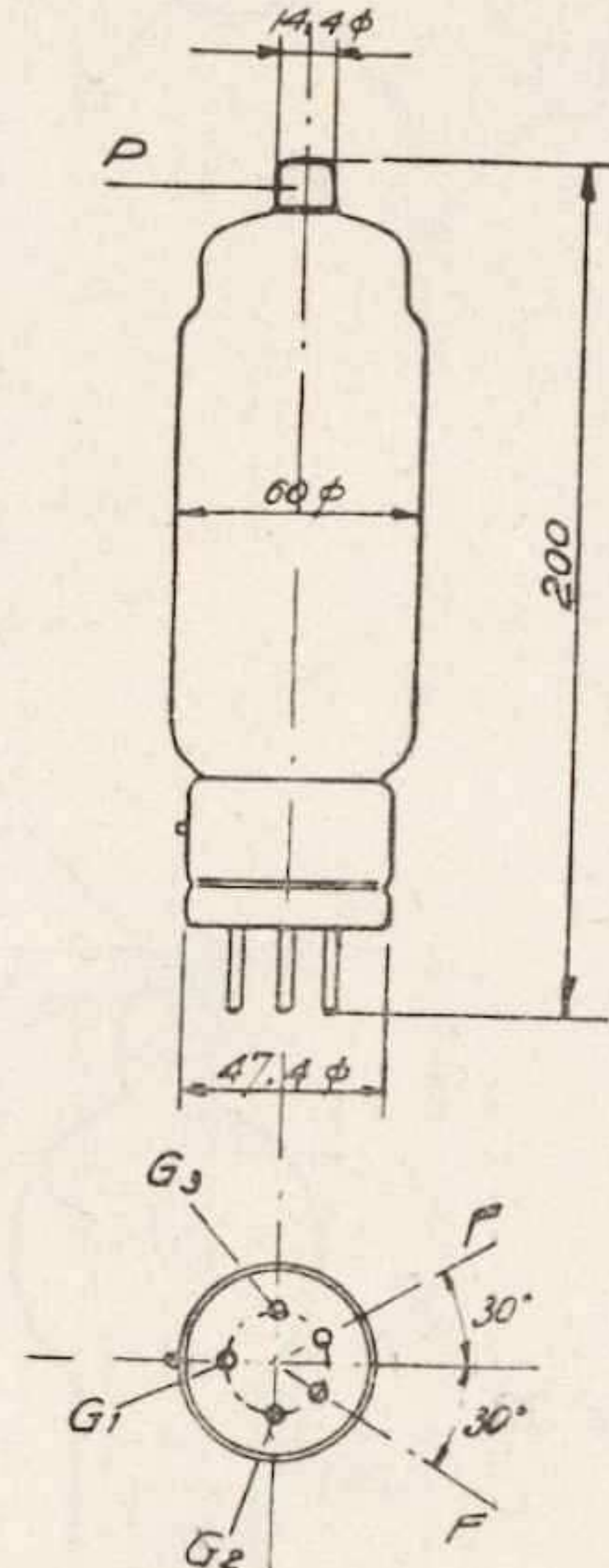
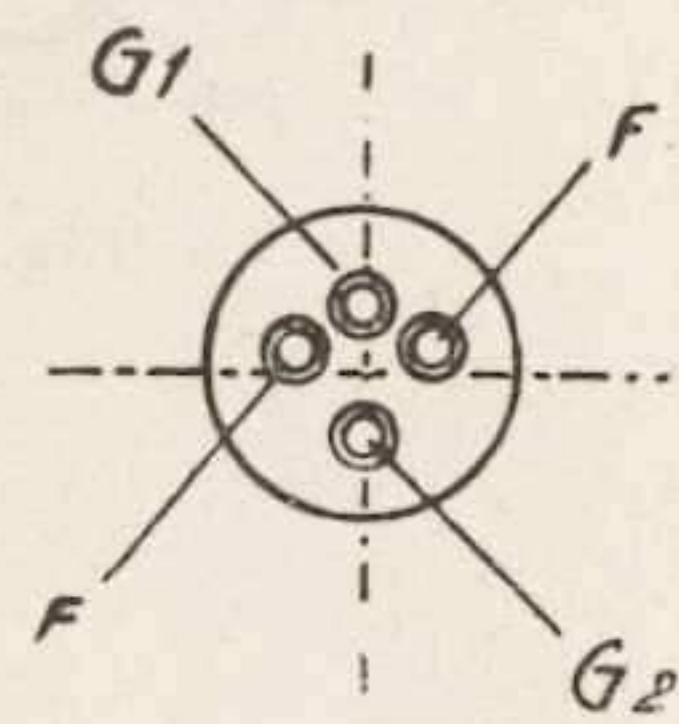

Fig. 9 a

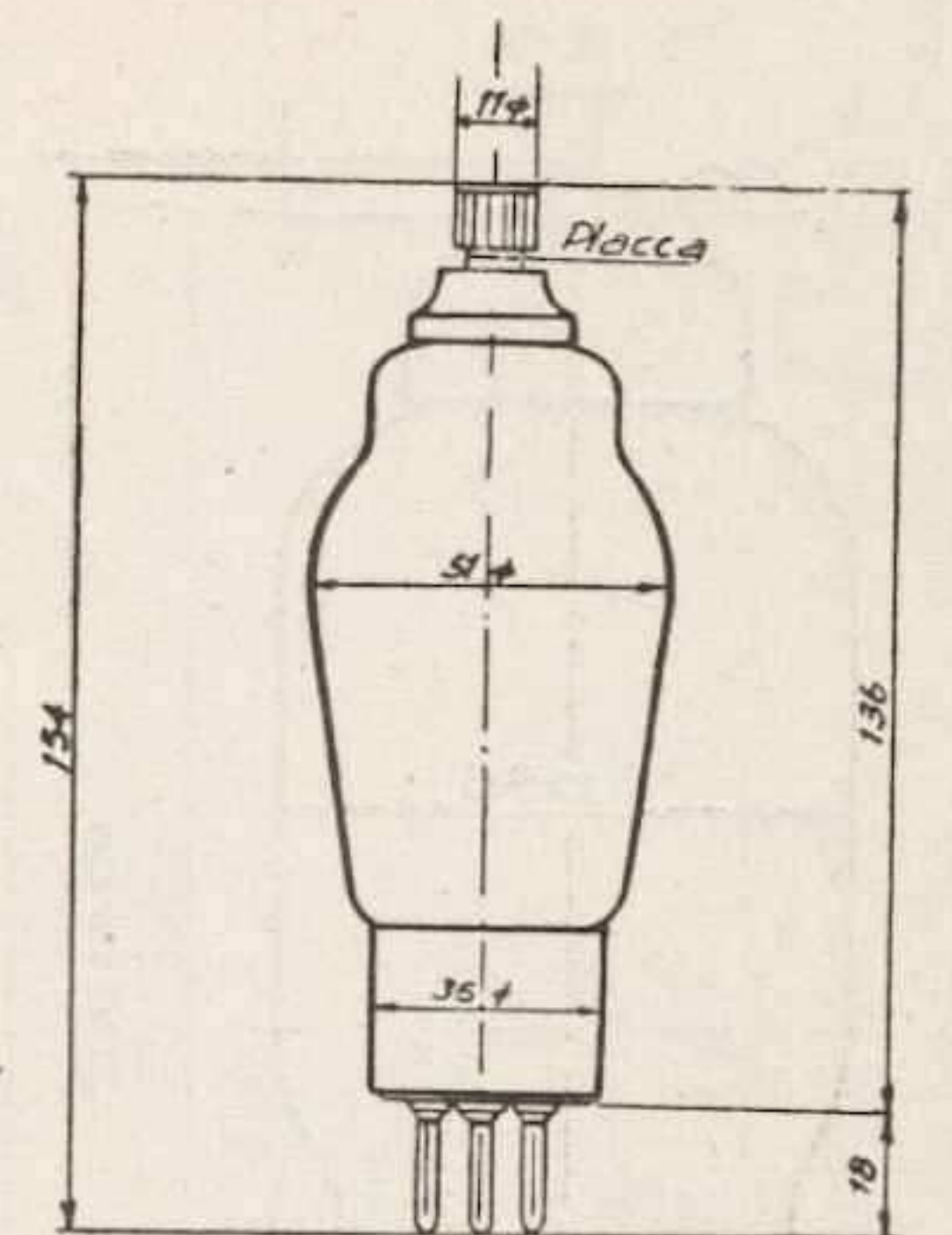

Fig. 7

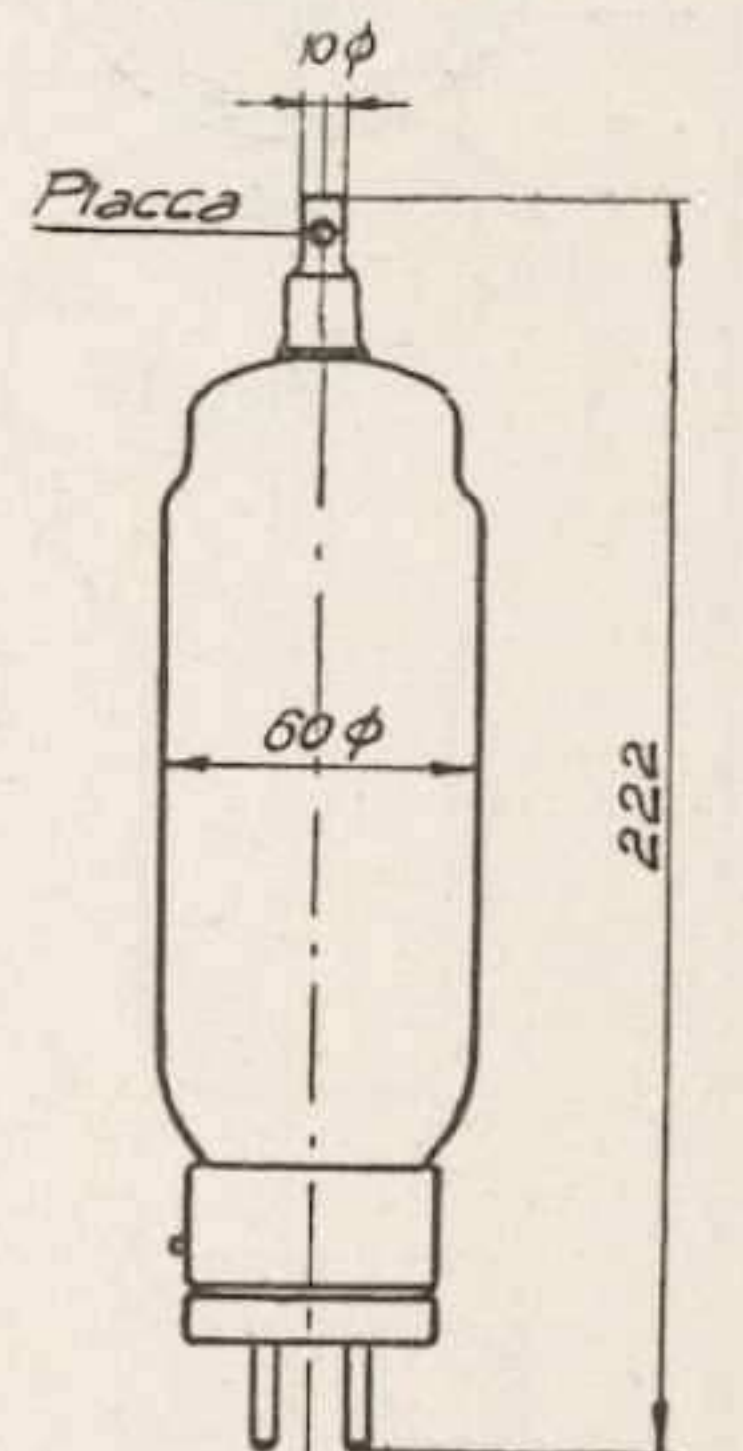
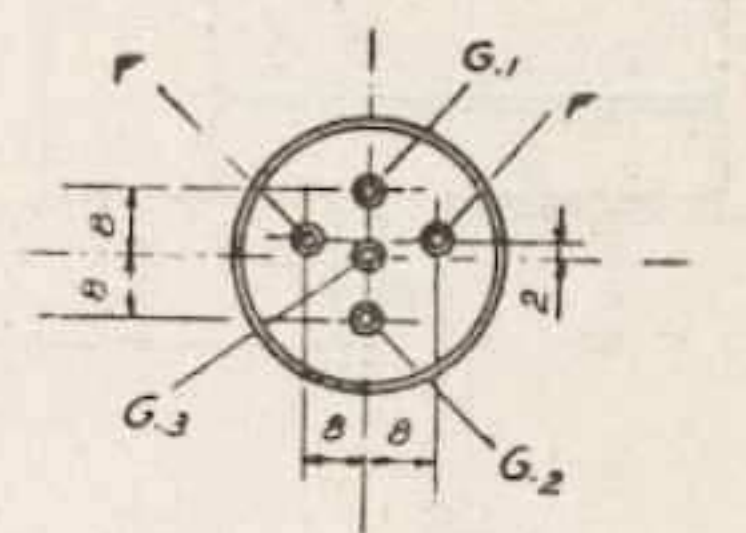
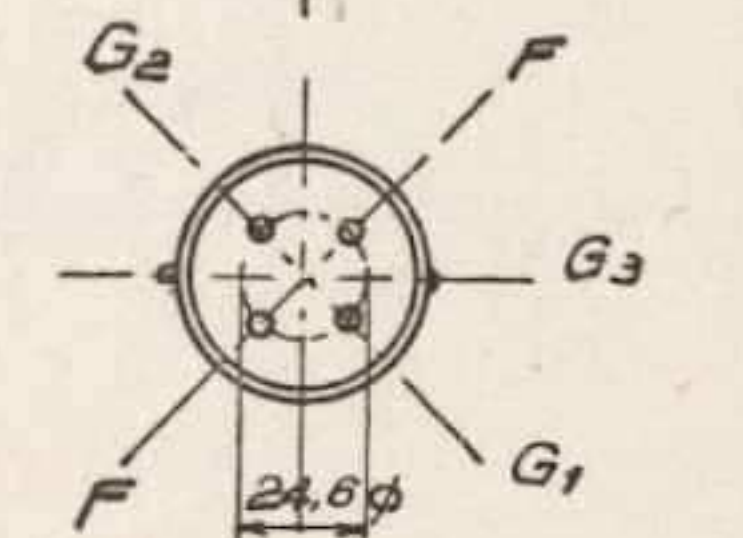

Fig. 9 b



DIMENSIONI DEI TUBI TRASMITTENTI "FIVRE,,

DIMENSIONI DEI TUBI TRASMETTENTI "FIVRE,,

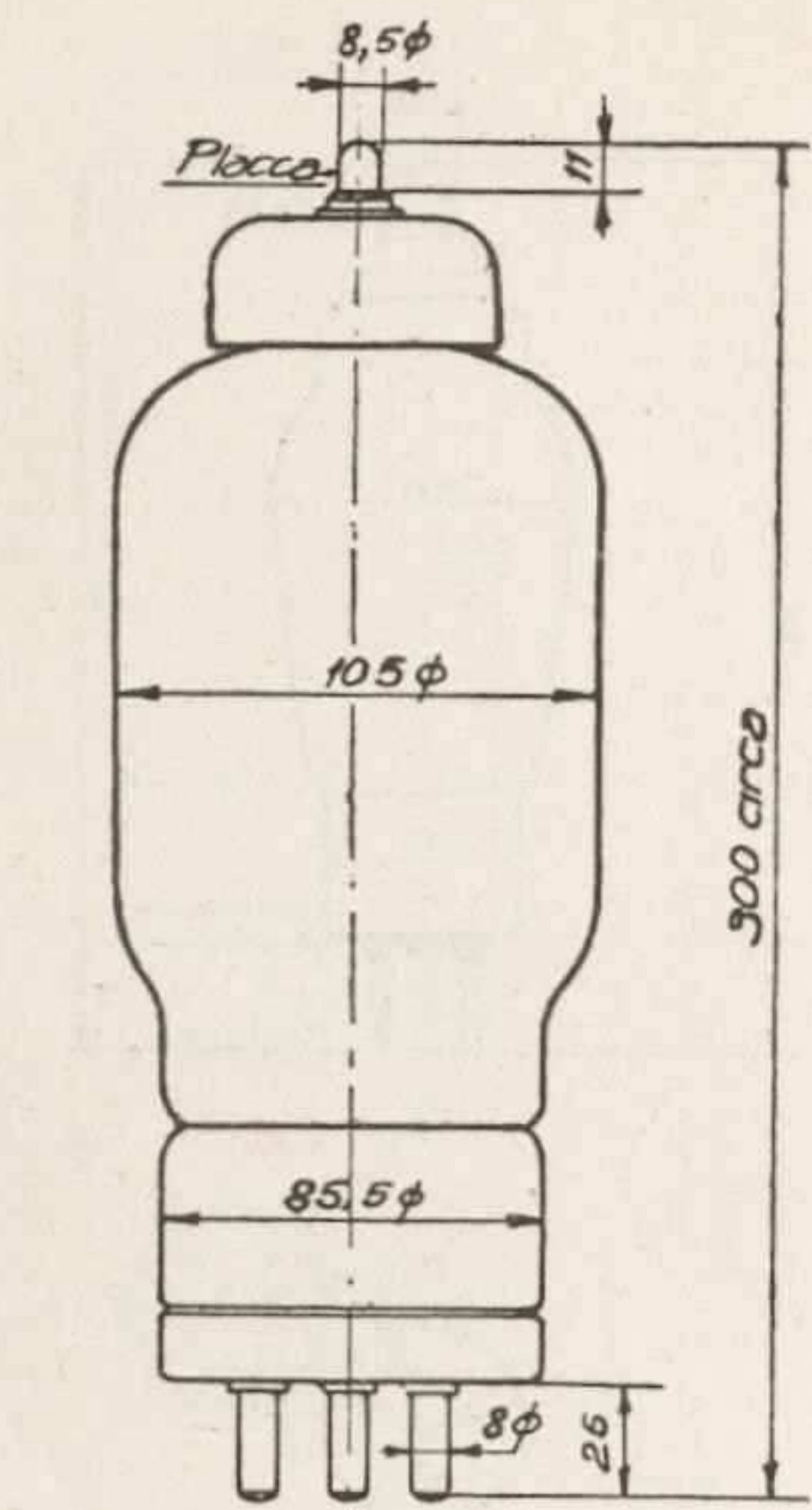

Fig. 10

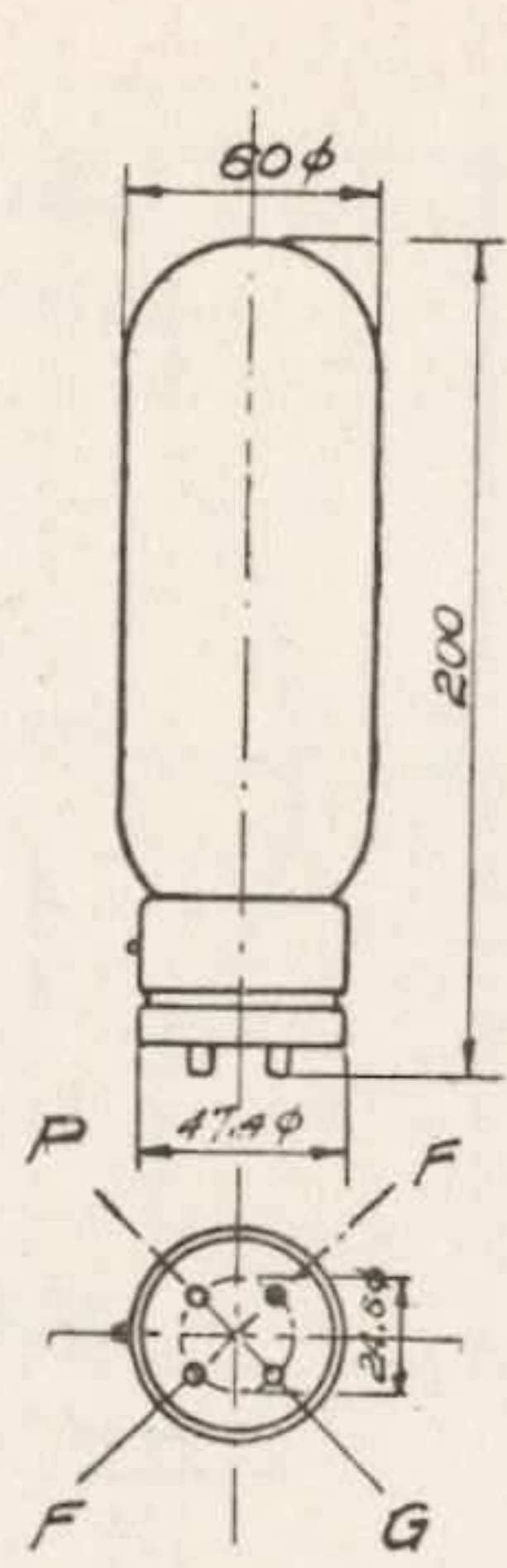

Fig. 11

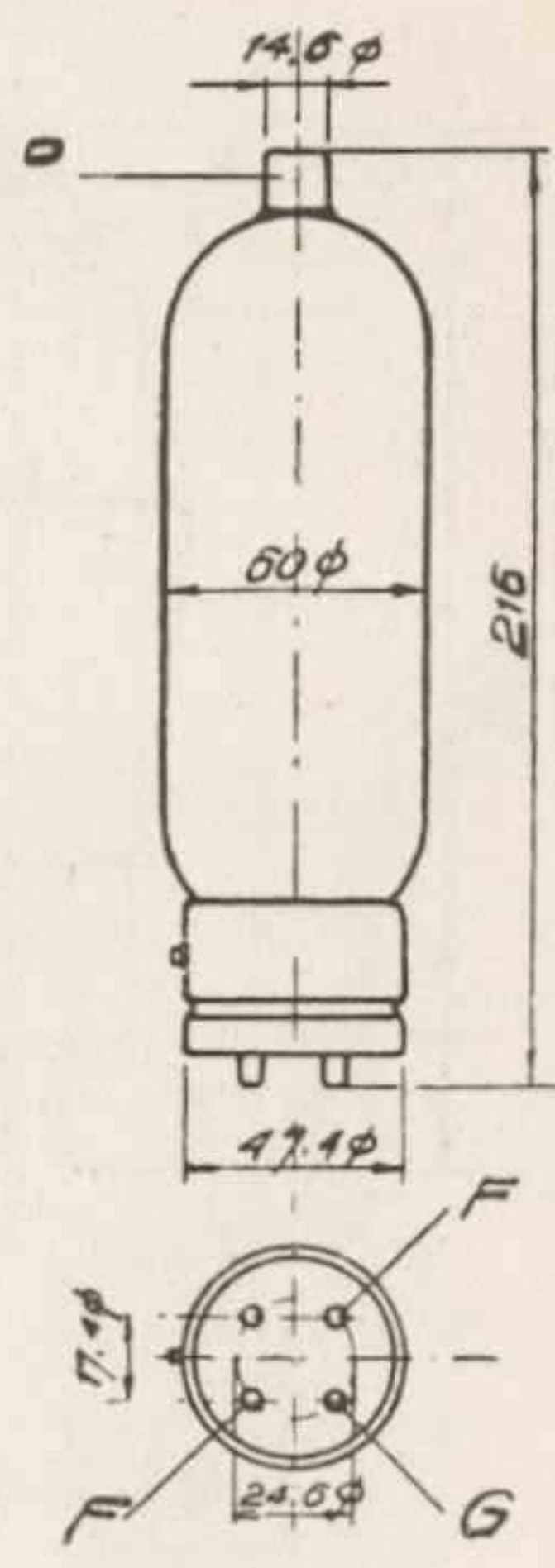

Fig. 12

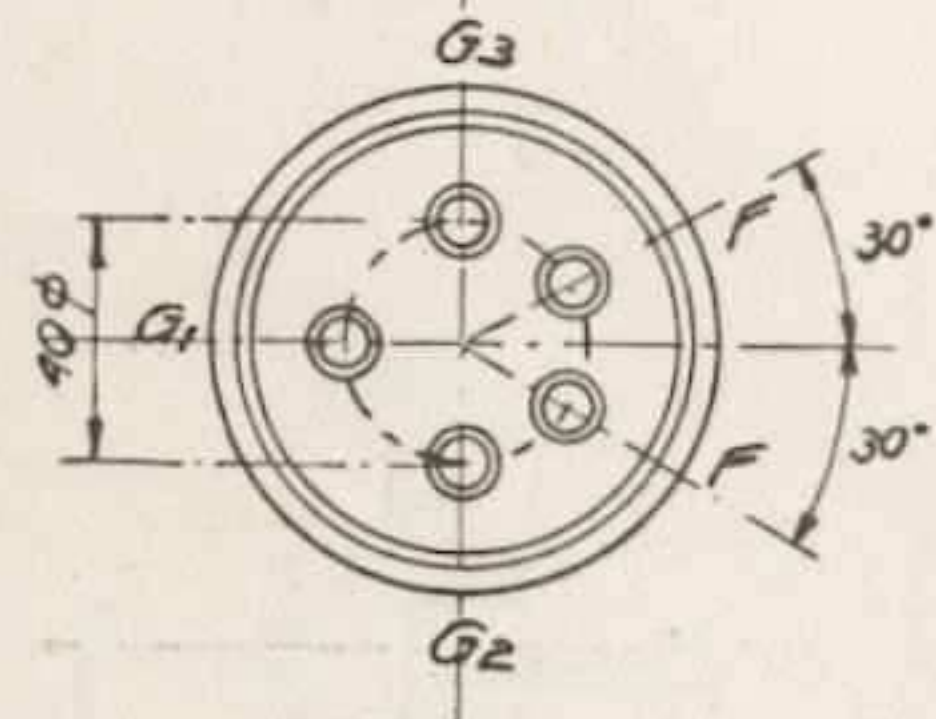

Fig. 13

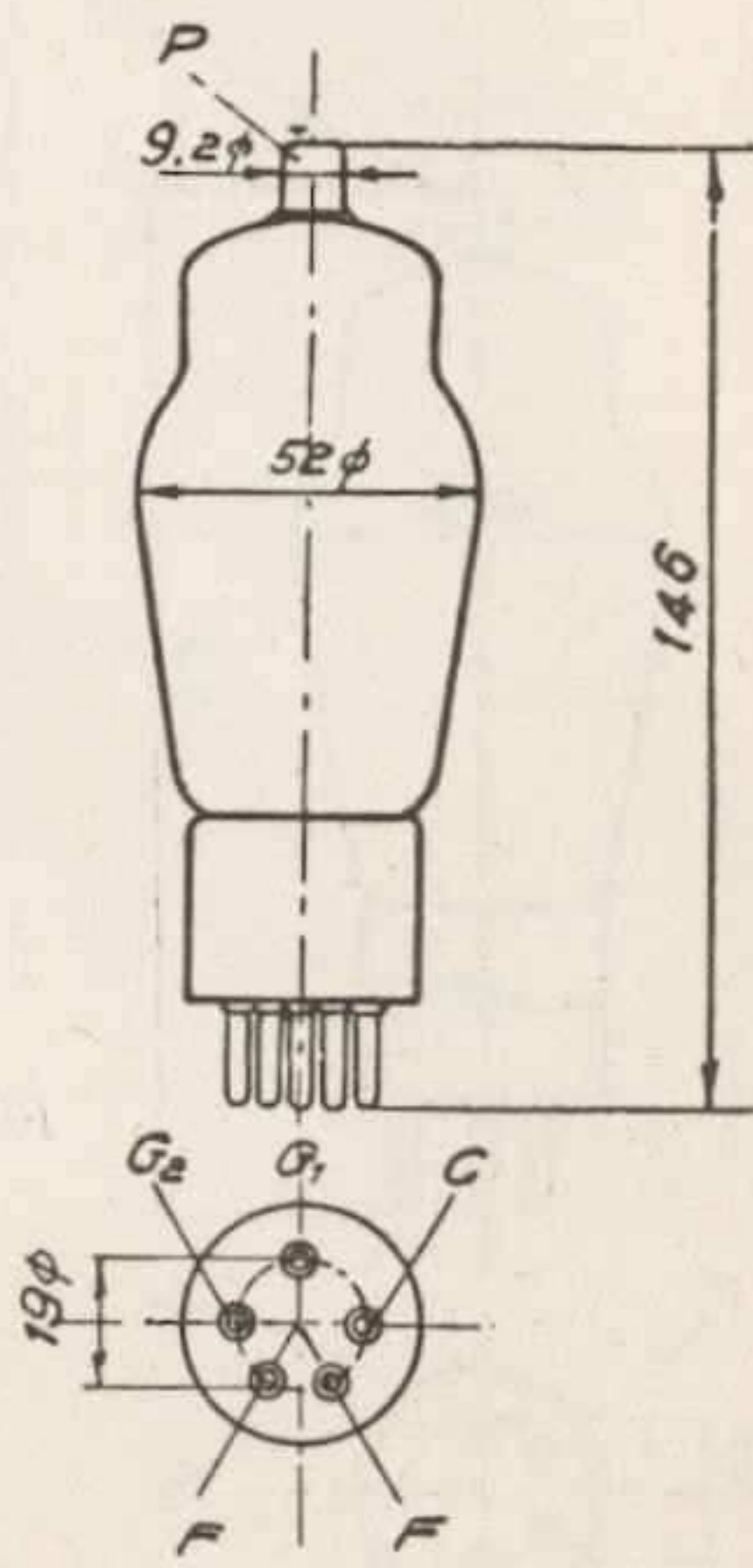
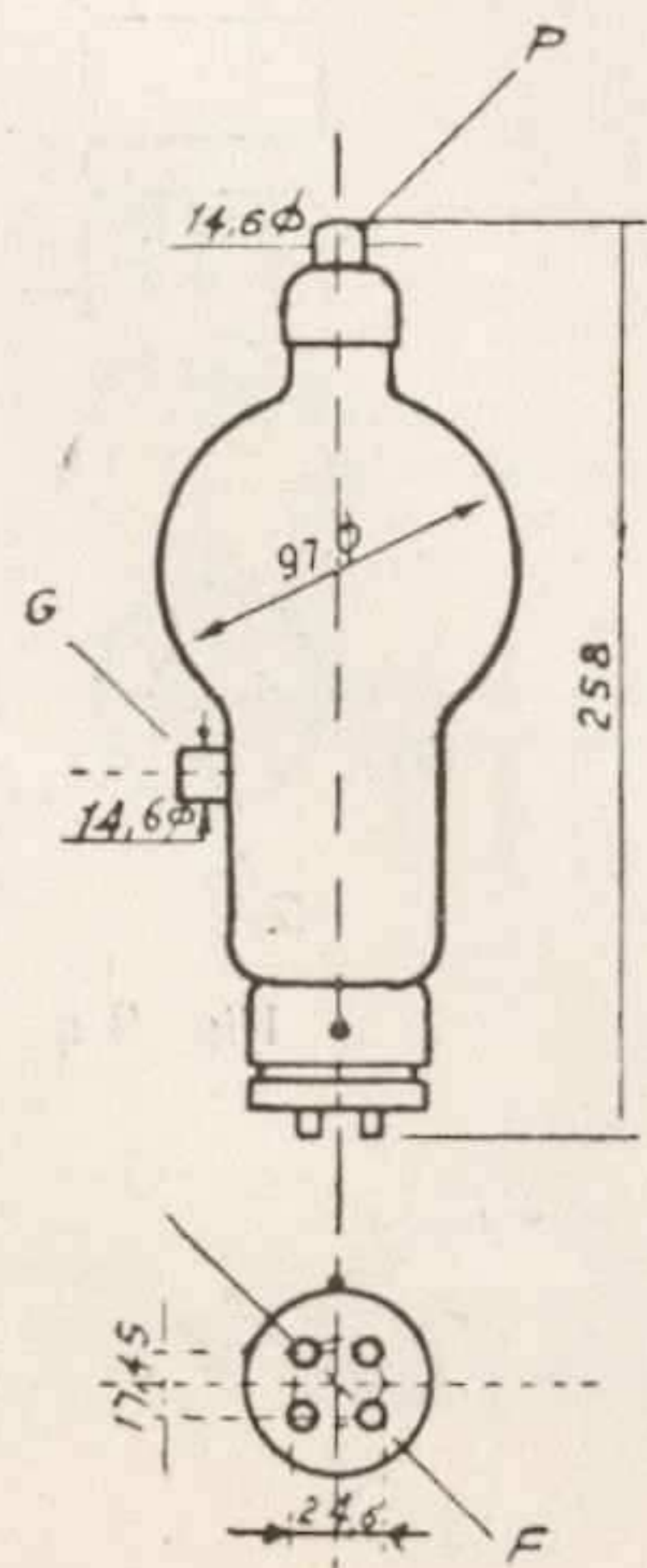

Fig. 14

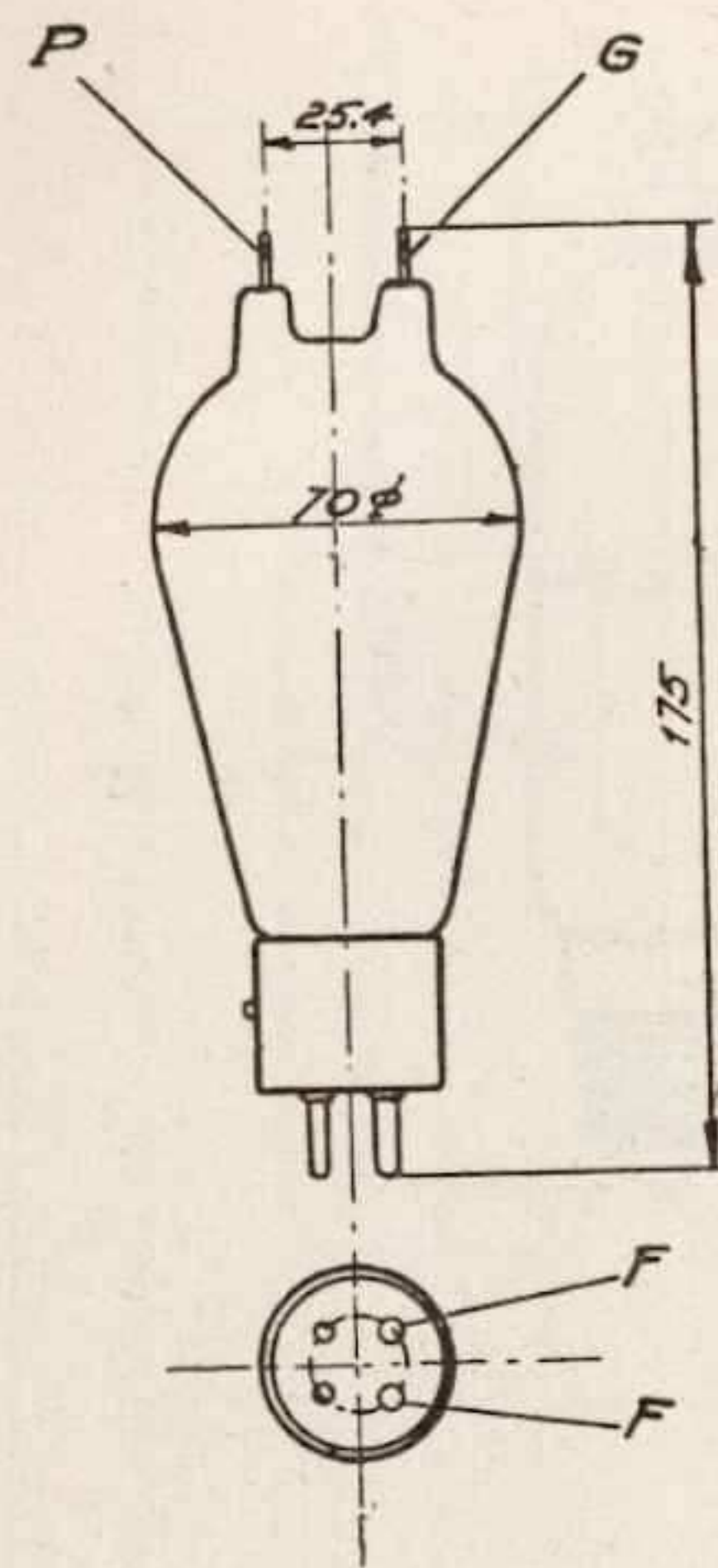

Fig. 15

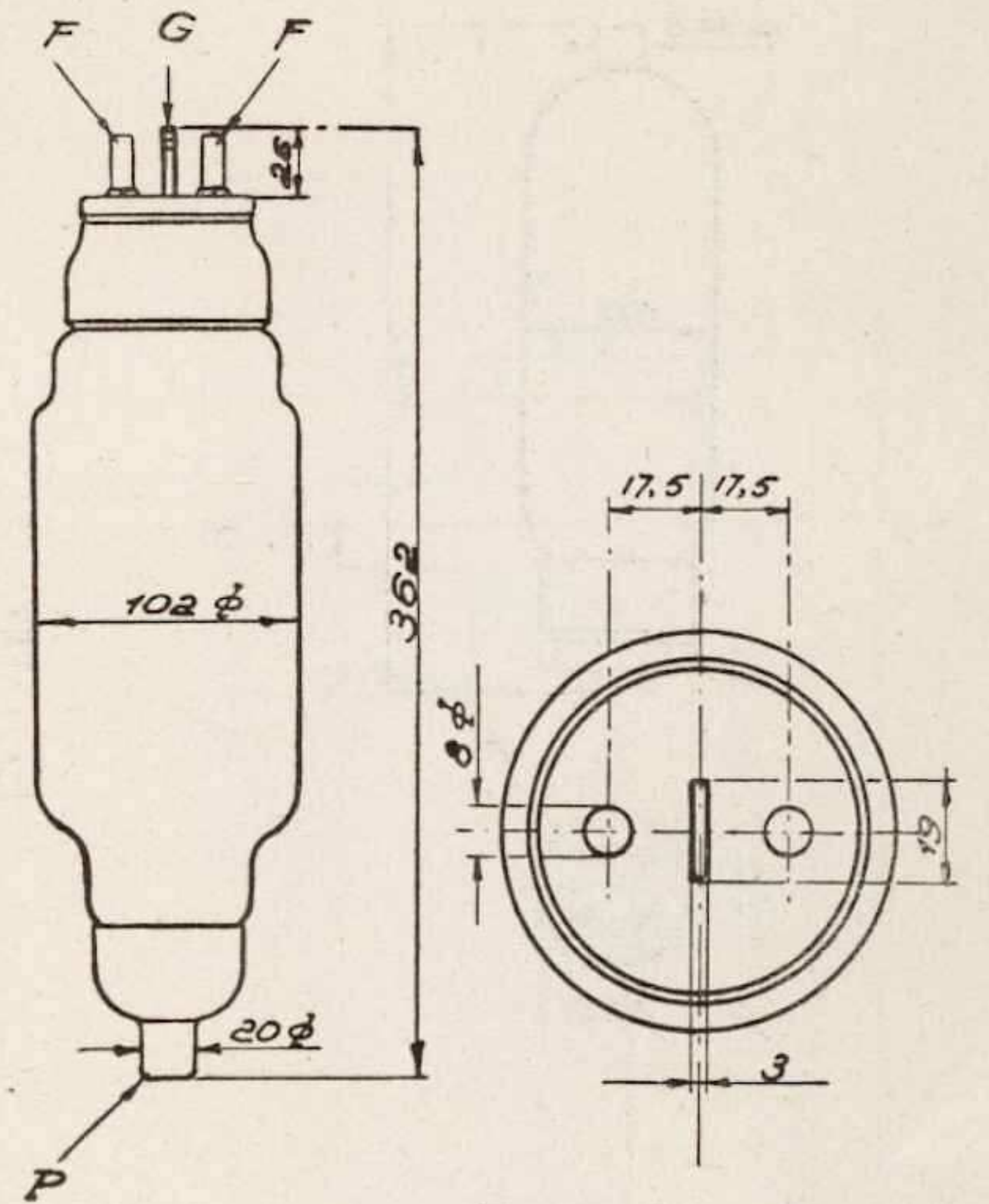

Fig. 16

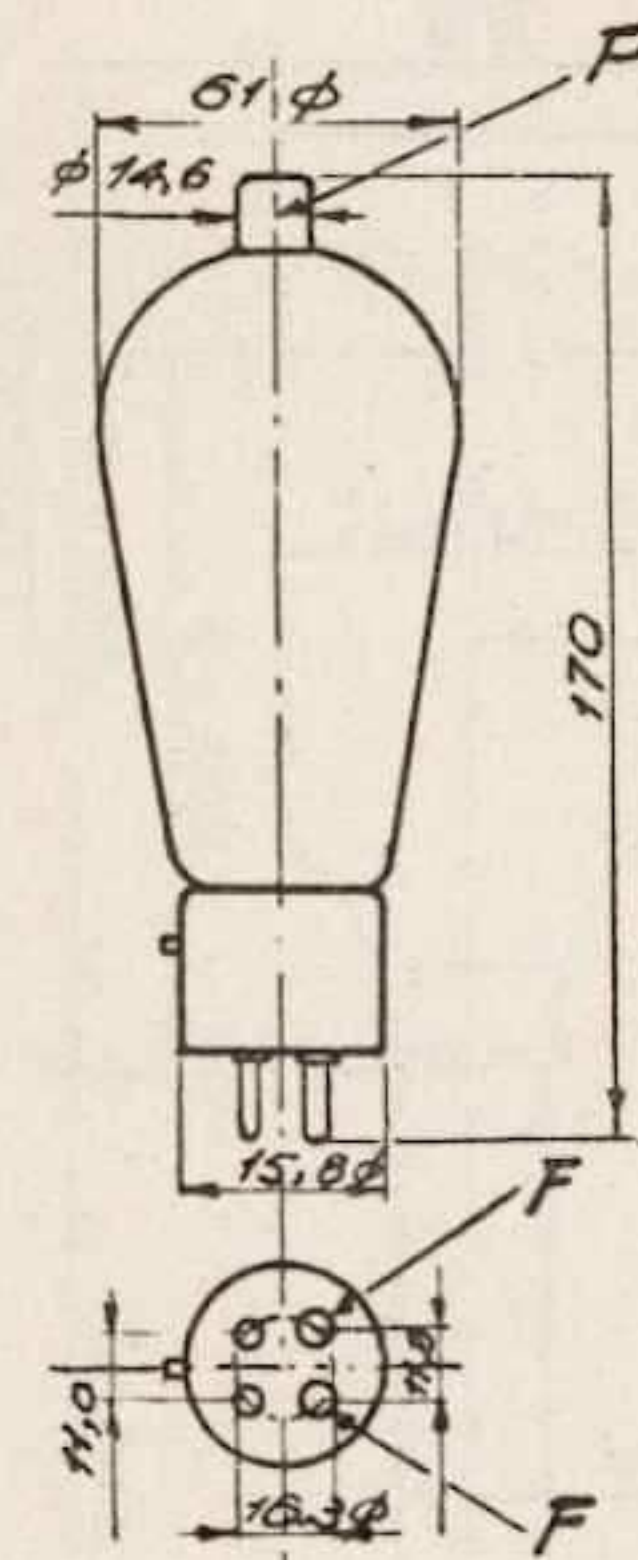

Fig. 17

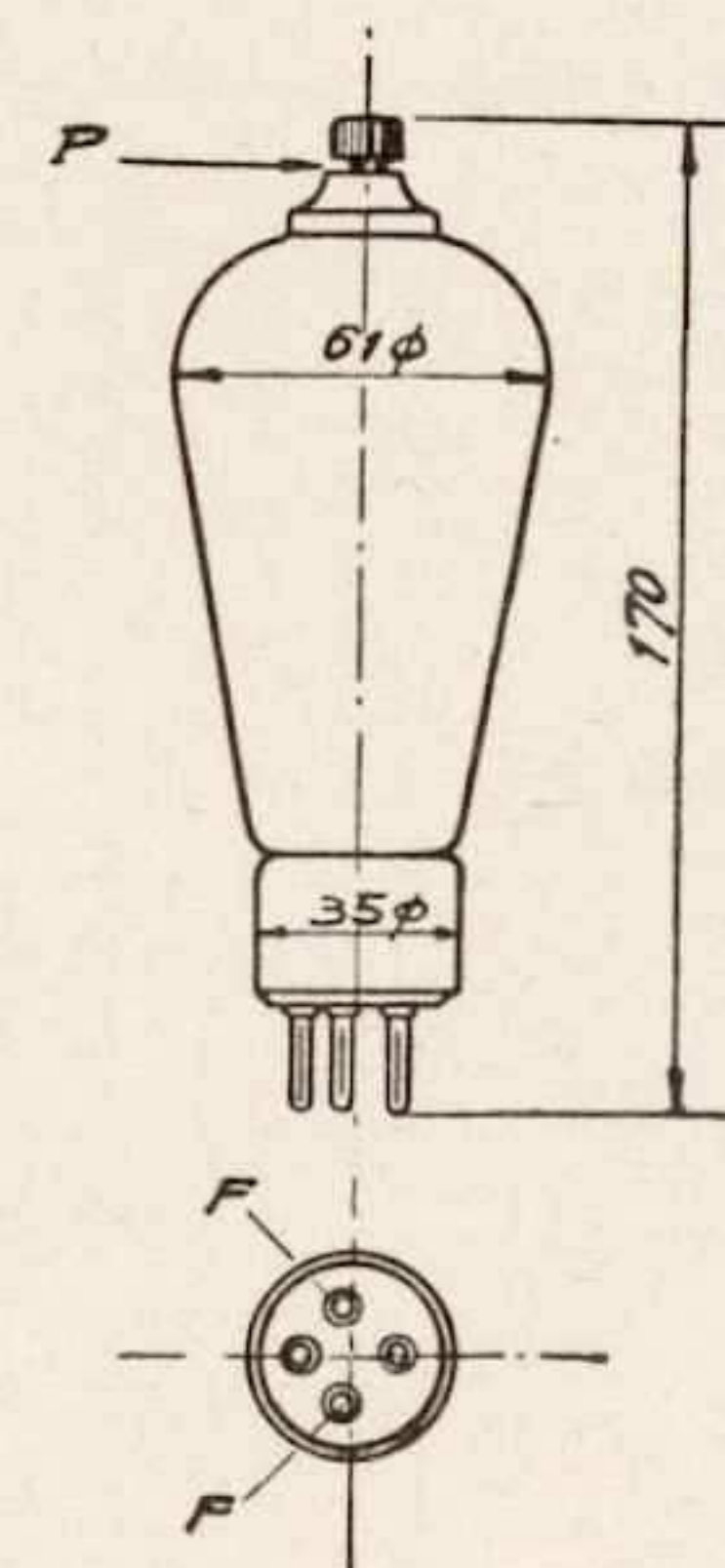

Fig. 18

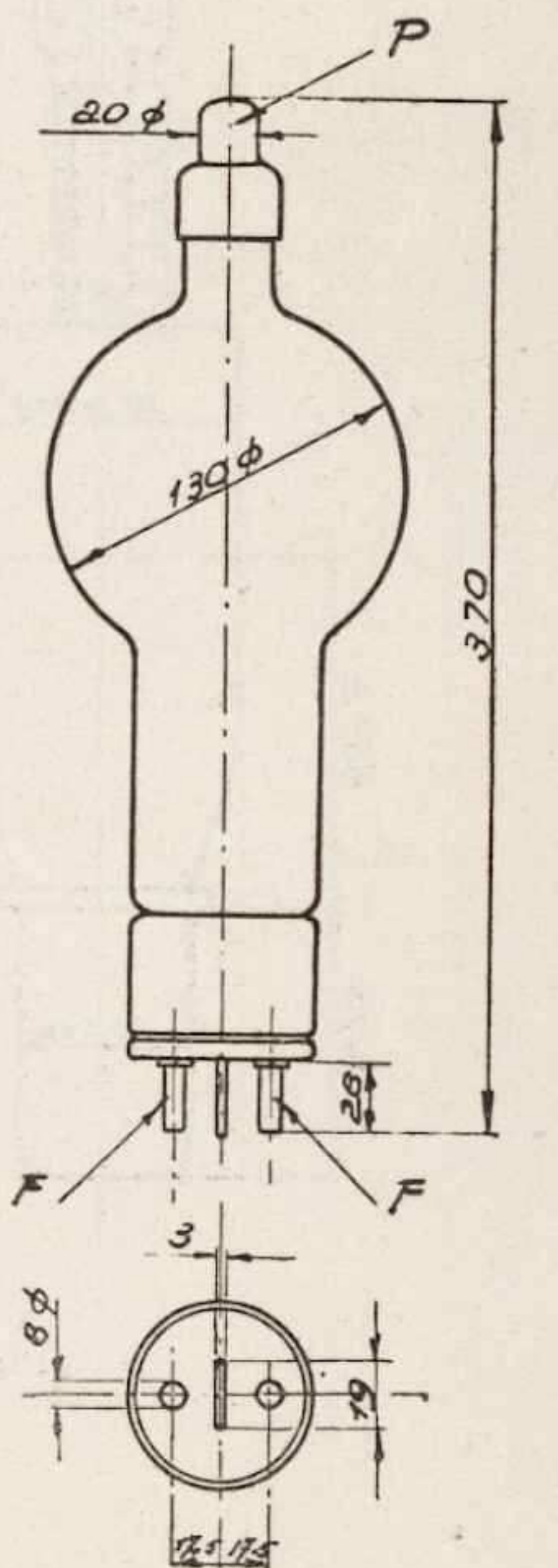

Fig. 19

DIMENSIONI DEI TUBI TRASMETTENTI "FIVRE,,

DIMENSIONI DEI TUBI TRASMITTENTI "FIVRE,,

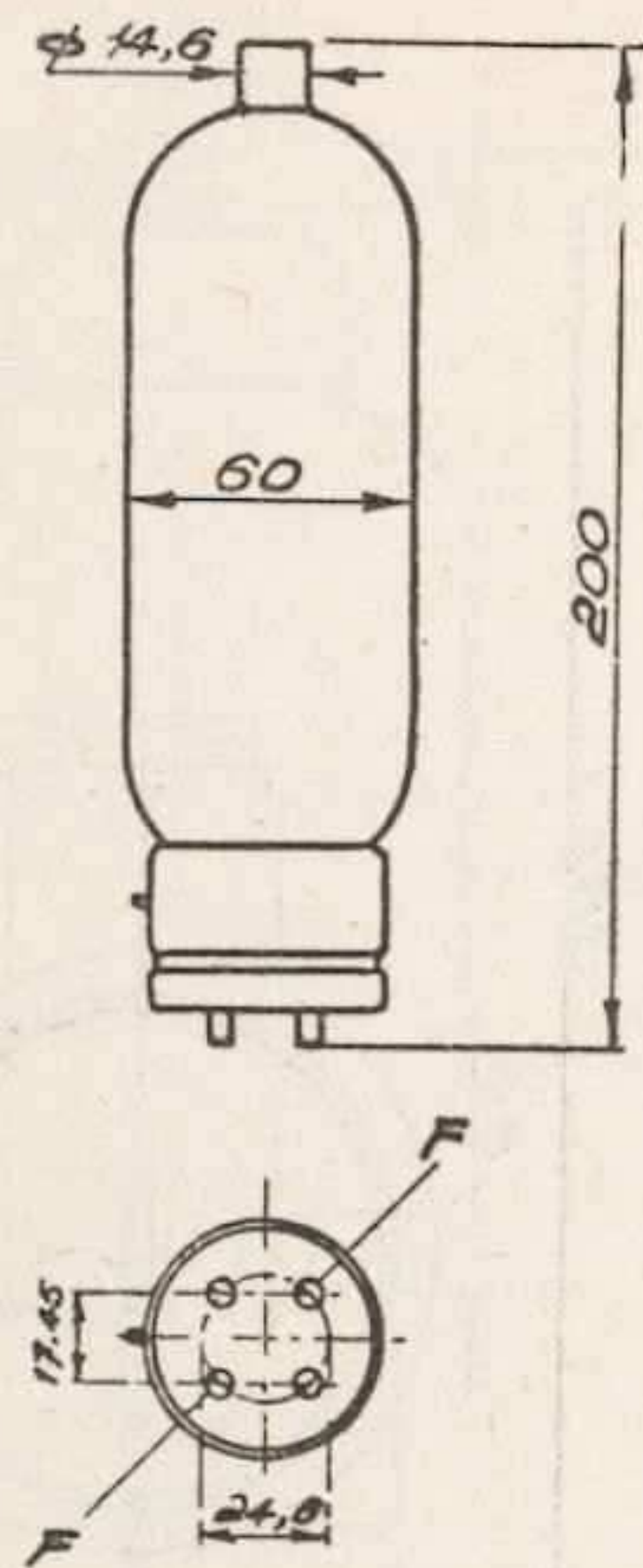

Fig. 20

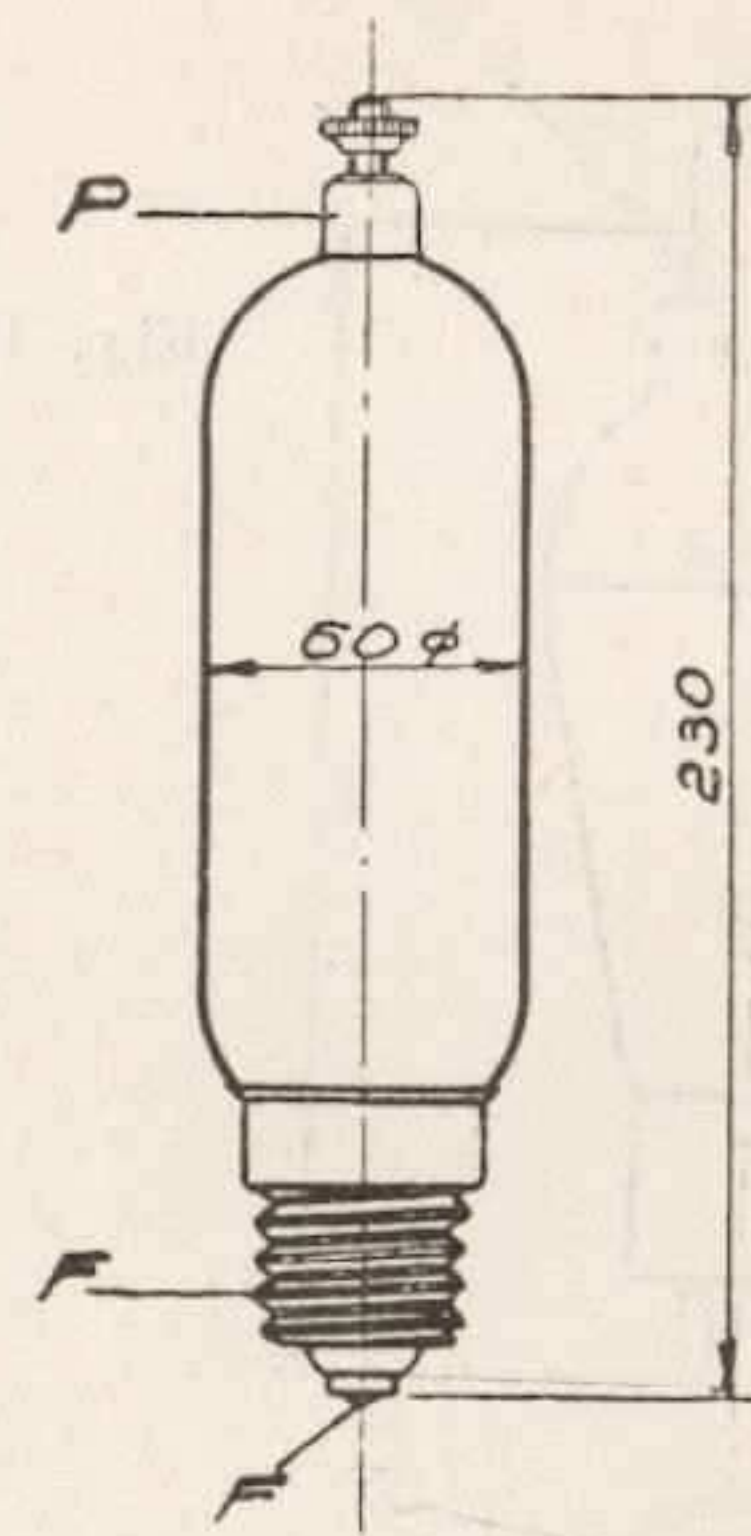

Fig. 21

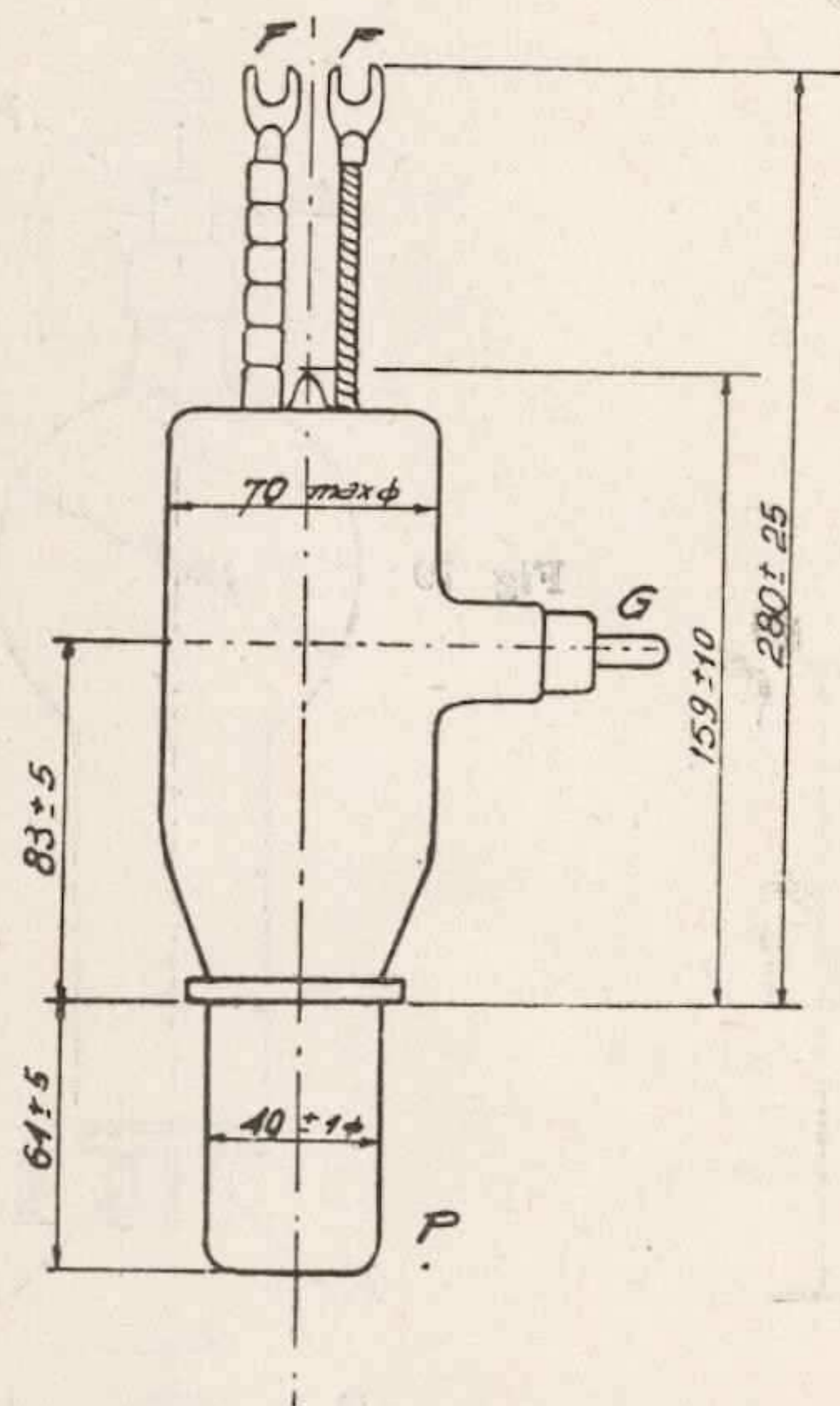

Fig. 23

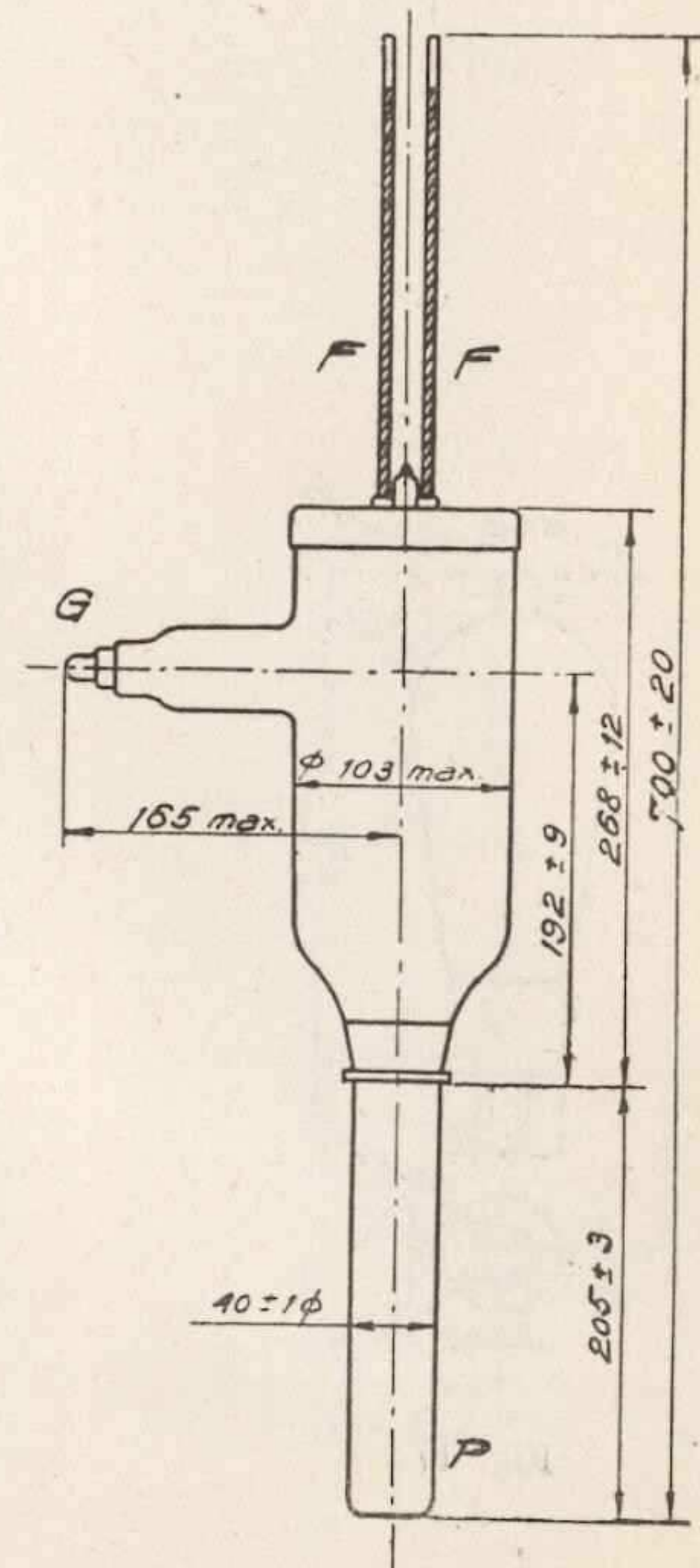

Fig. 22

DIMENSIONI DEI TUBI TRASMITTENTI "FIVRE,,

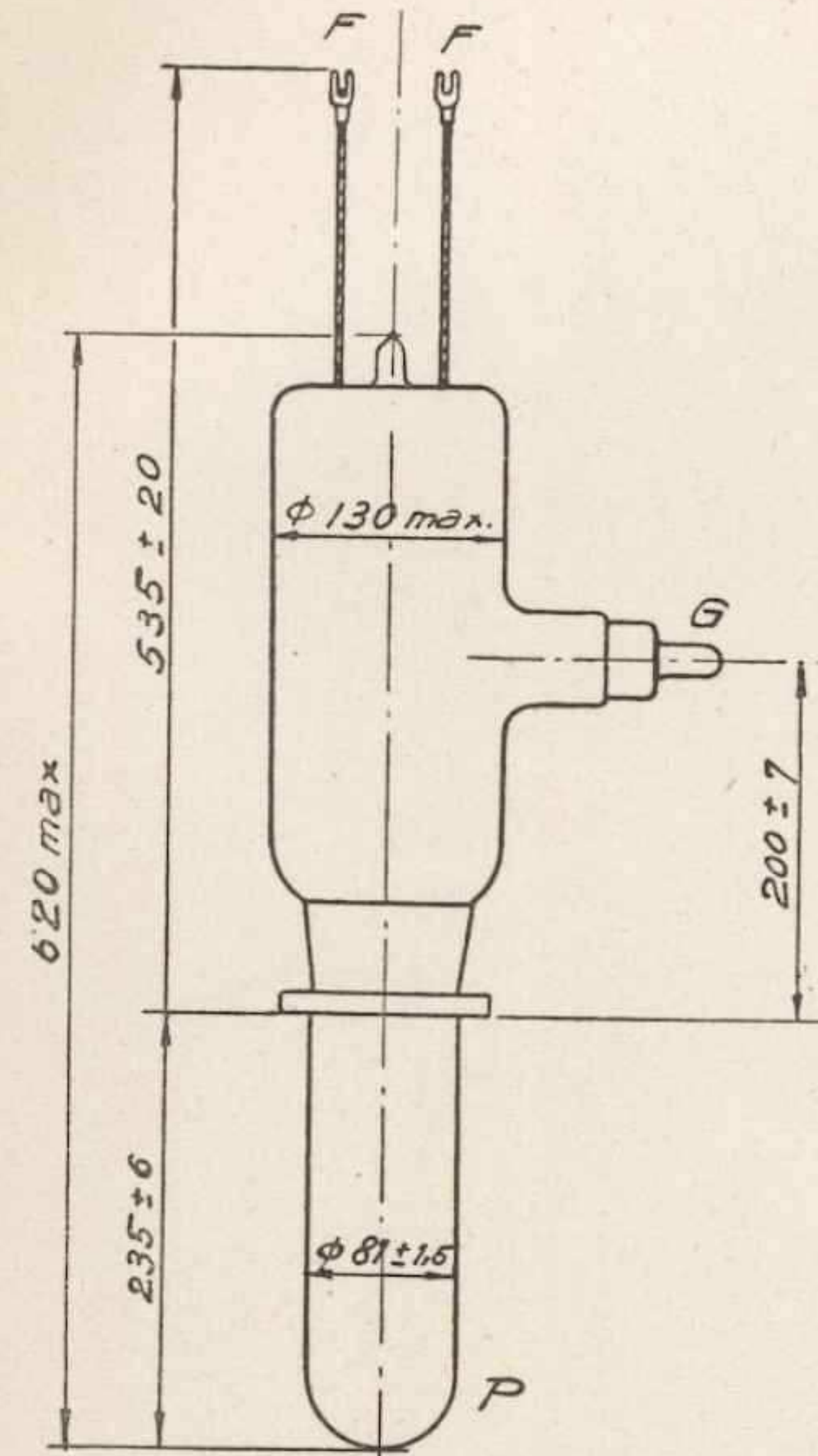

Fig. 24

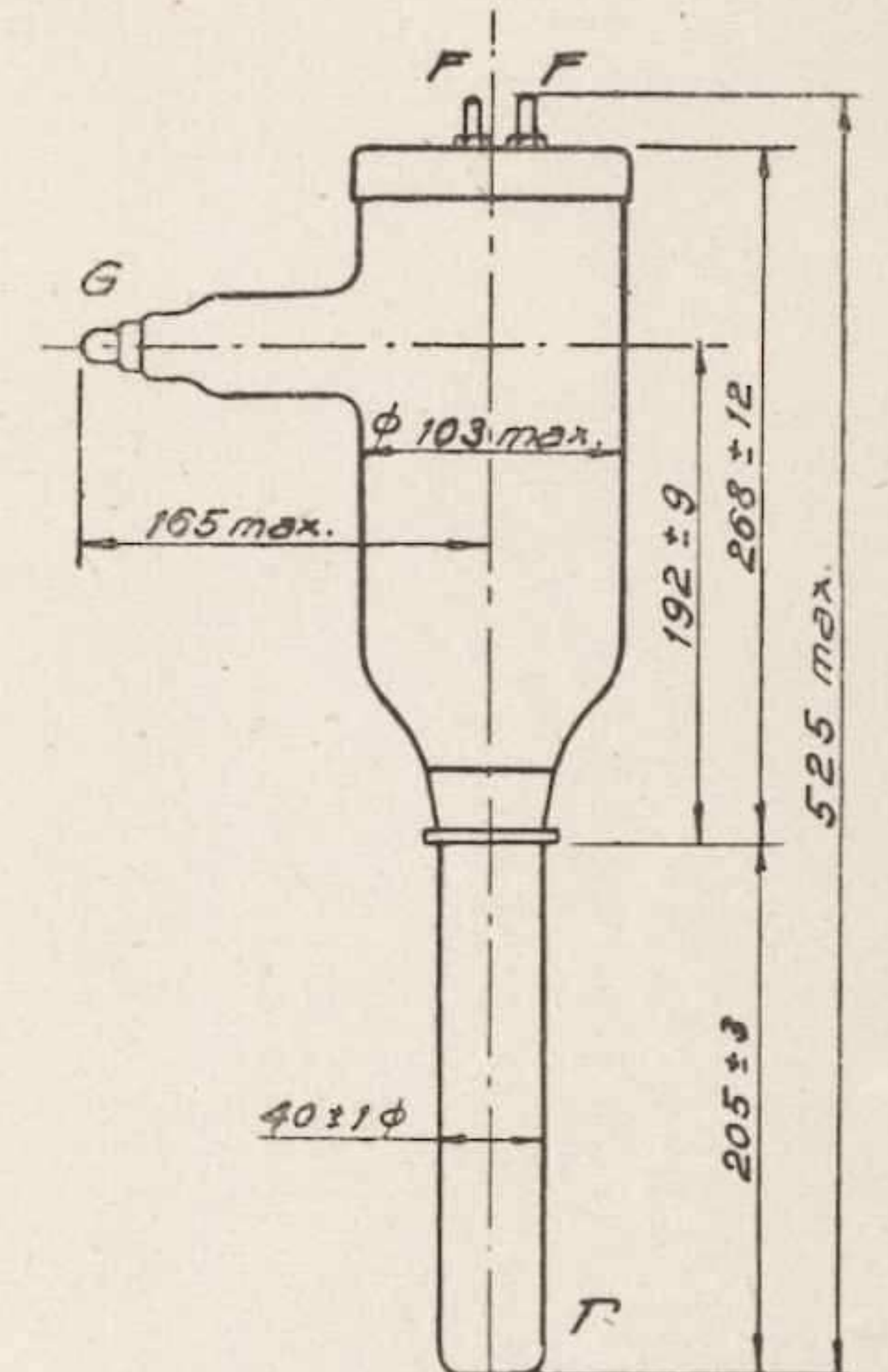

Fig. 25

