

ML-8534

ML-8535



**Miniature  
 UHF Planar Triodes**

CW, Plate or Grid Pulsed  
 Frequency Stable  
 Phormat Cathode  
 High Cathode-Current Capability  
 100W CW at 2.3 GHz

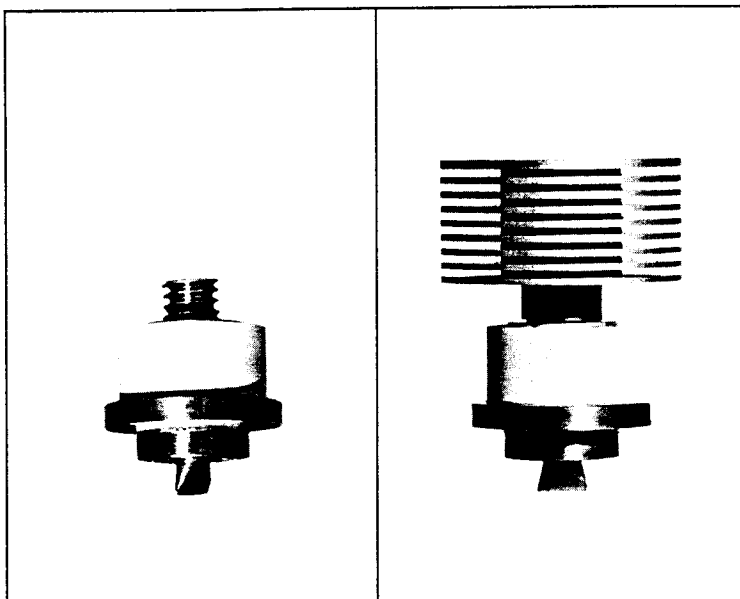

**DESCRIPTION**

The ML-8534 and ML-8535 are ruggedized, high-mu planar triodes of ceramic-and-metal construction, designed for use as grid-pulsed, plate-pulsed or CW oscillators, frequency multipliers, or amplifiers in radio transmitting service from low frequency to 3 GHz. The ML-8534 is supplied without a radiator for conduction-convection or heat-sink cooling. The ML-8535 is supplied with a radiator for forced-air cooling. Except for plate-dissipation ratings, the characteristics of the two tubes are the same.

Distinguishing characteristics of these tubes are their min-

iaturation and high cathode-current capability. In addition to low interelectrode capacitance, high transconductance and high mu, these tubes also incorporate design features which help to assure frequency-stable operation even under conditions of adverse ambient temperature and varying plate dissipation. The tubes also employ a Phormat type cathode which consists of an indirectly heated disc with an oxide coating impregnated in a nickel matrix. This construction, in combination with proper plate series impedance, reduces to a minimum failures of the cathode due to voltage surges.

*Note: Data contained herein are based on initial design and test criteria. Before using these data in final equipment designs, consult Machlett for possible revisions.*

**GENERAL CHARACTERISTICS**

**Electrical**

Heater Voltage (AC or DC) .....	6.3 V
Heater Current at 6.3 Volts .....	1.30 A
Cathode Heating Time, minimum .....	60 sec
Amplification Factor .....	80
Transconductance ( $J_k=200\text{mA}/\text{cm}^2$ ) .....	38000 $\mu\text{mhos}$
Interelectrode Capacitance, without Heater Voltage	
Grid-Plate .....	2.25 pf
Grid-Cathode .....	9.5 pf
Plate-Cathode, maximum .....	.065 pf

**Mechanical**

Mounting Position .....	Optional
Type of Cooling	
With radiator (ML-8535) .....	Forced-Air
Without radiator (ML-8534) .....	Conduction & Convection
Maximum Anode Temperature .....	250 °C
Net Weight	
With radiator (ML-8535) .....	45 g
Without radiator (ML-8534) .....	20 g

**MAXIMUM RATINGS AND  
TYPICAL OPERATING CONDITIONS**

**CW RF Power Oscillator and Amplifier  
Class C**

Maximum Ratings, Absolute Values

DC Plate Voltage .....	2500	V
DC Grid Voltage .....	-150	V
Instantaneous Peak Grid-Cathode Voltage		
Grid negative to cathode .....	-400	v
Grid positive to cathode .....	30	v
DC Plate Current .....	250	mA
DC Grid Current .....	45	mA
Plate Dissipation		
Forced-air cooling (ML-8535) .....	150	W
Conduction and convection (ML-8534) .....	10	W†
Grid Dissipation .....	1.5	W
Frequency .....	2.5	GHz

Typical Operation, Power Amplifier

Frequency .....	500	MHz
Filament Voltage .....	6.0	V
DC Plate Voltage .....	900	V
DC Grid Voltage .....	-30	V
DC Plate Current .....	140	mA
DC Grid Current, approximate .....	40	mA
Driving Power, approximate .....	9	W
Useful Power Output .....	65	W

Typical Operation, Power Amplifier

Frequency .....	2.3	GHz
Filament Voltage .....	5.5	V
DC Plate Voltage .....	1400	V
DC Plate Current .....	250	mA
Useful Power Output .....	100	W
Gain .....	13	db

**Grid-Pulsed or Plate-Pulsed RF Oscillator  
or Amplifier—Class C**

Maximum Ratings, Absolute Values

Plate Voltage		
Grid-pulsed, DC .....	2500	V
Plate-pulsed, peak pulse supply .....	3500	v
DC Grid Voltage .....	-150	V
Instantaneous Peak Grid-Cathode Voltage		
Grid negative to cathode .....	-750	v
Grid positive to cathode .....	250	v
Average Plate Current .....	16	mA
Average Grid Current .....	6	mA
Pulse Plate Current .....	5	a
Average Plate Dissipation		
Forced-air cooling (ML-8535) .....	60	W
Conduction and convection (ML-8534) .....	10	W†
Average Grid Dissipation .....	1.5	W
Pulse Duration .....	6	μs††
Duty Factor .....	.0033	††
Frequency .....	3	GHz

Typical Operation, Grid-Pulsed RF Amplifier

Frequency .....	1.1	GHz
Filament Voltage .....	6.3	V
Pulse Duration .....	3.5	μs
Duty Factor .....	.001	
DC Plate Voltage .....	2000	V
DC Grid Voltage .....	-70	V
Peak Plate Current from DC Supply .....	3.0	a
Peak Grid Current from Pulse Supply .....	1.0	a
Driving Power During Pulse, approximate .....	400	W
Useful Peak Power Output, approximate .....	2.5	kw

**Pulse Modulator or Pulse Amplifier**

Maximum Ratings, Absolute Values

DC Plate Voltage .....	2500	V
Peak Plate Voltage .....	3500	v
DC Grid Voltage .....	-150	V
Instantaneous Peak Grid-Cathode Voltage		
Grid negative to cathode .....	-750	v
Grid positive to cathode .....	110	v
DC Plate Current .....	150	mA
Pulse Cathode Current .....	7.5	a
Average Plate Dissipation		
Forced-air cooling (ML-8535) .....	150	W
Conduction and convection (ML-8534) .....	10	W†
Average Grid Dissipation .....	1.5	W
Pulse Duration .....	6	μs††
Duty Factor .....	.0033	††

†Greater plate dissipation will be possible with the ML-8534 when the tube is used with an appropriately designed heat sink.

††For applications requiring longer pulse duration or higher duty factors, consult the Machlett Engineering Department.

**CHARACTERISTIC RANGE VALUES  
FOR EQUIPMENT DESIGN**

	Min.	Max.
Filament Current at 6.3 V (Note 1) .....	1.20	1.40
Cut-Off Bias (Note 2) .....	—	-30
Grid-Plate Capacitance (Note 3) .....	2.10	2.40
Grid-Cathode Capacitance (Note 3) .....	8.50	10.50
Plate-Cathode Capacitance (Note 3) .....	—	.065

Note 1 — For reduced filament voltage see "Heater Voltage" section in *Application Notes*.

Note 2 — Measured with 1 mA plate current and a plate voltage of 1000 Vdc.

Note 3 — Capacitance values are given for a cold tube. When the filament is heated to its proper temperature, the grid-cathode capacitance will increase by approximately 1 pf due to thermal expansion of the cathode.

**APPLICATION NOTES**

Before designing equipment for use with these tubes and before installing tubes in equipment, refer to the general information given in the Machlett publication entitled *Application Notes, UHF Tubes—General*.

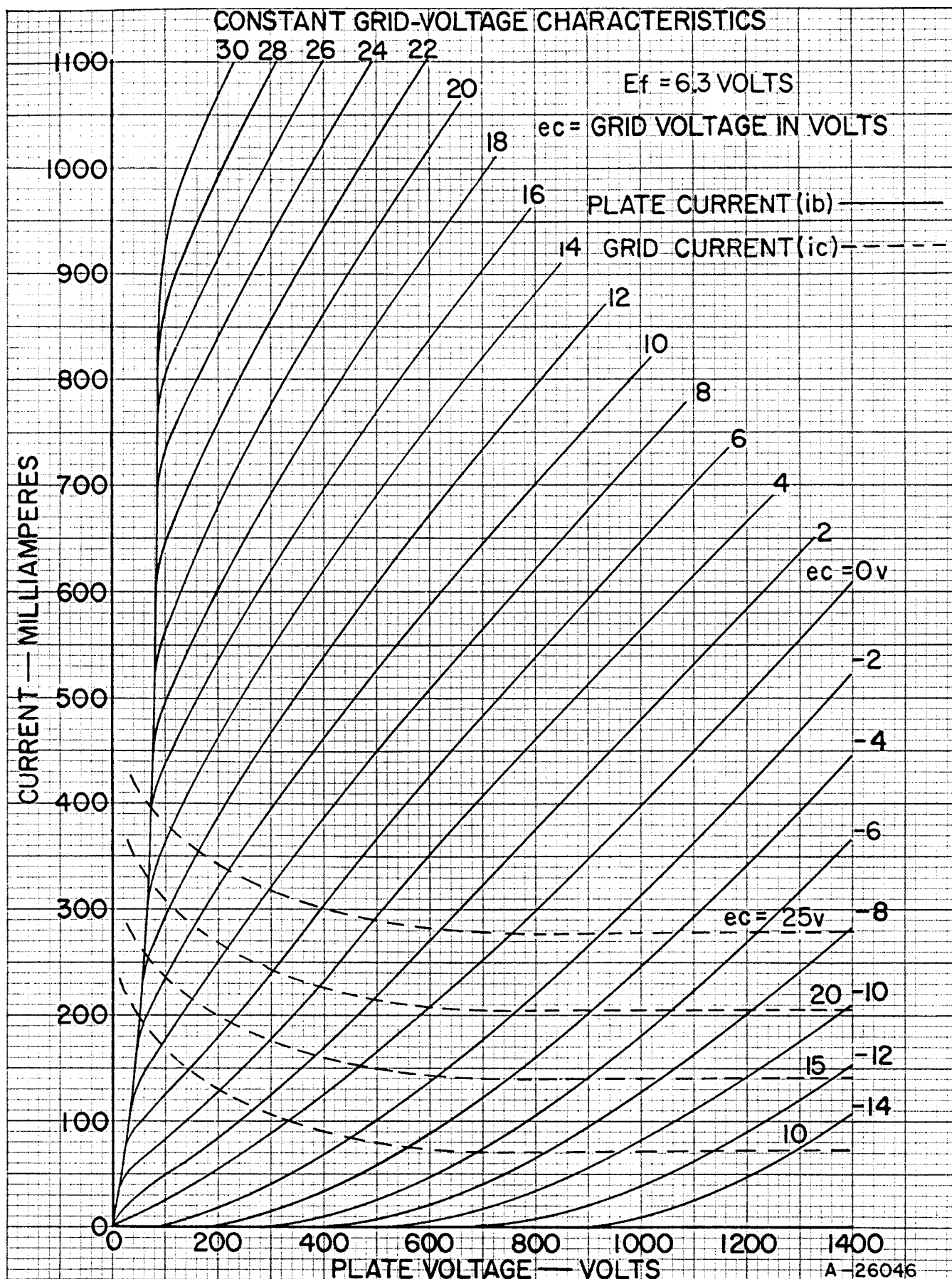

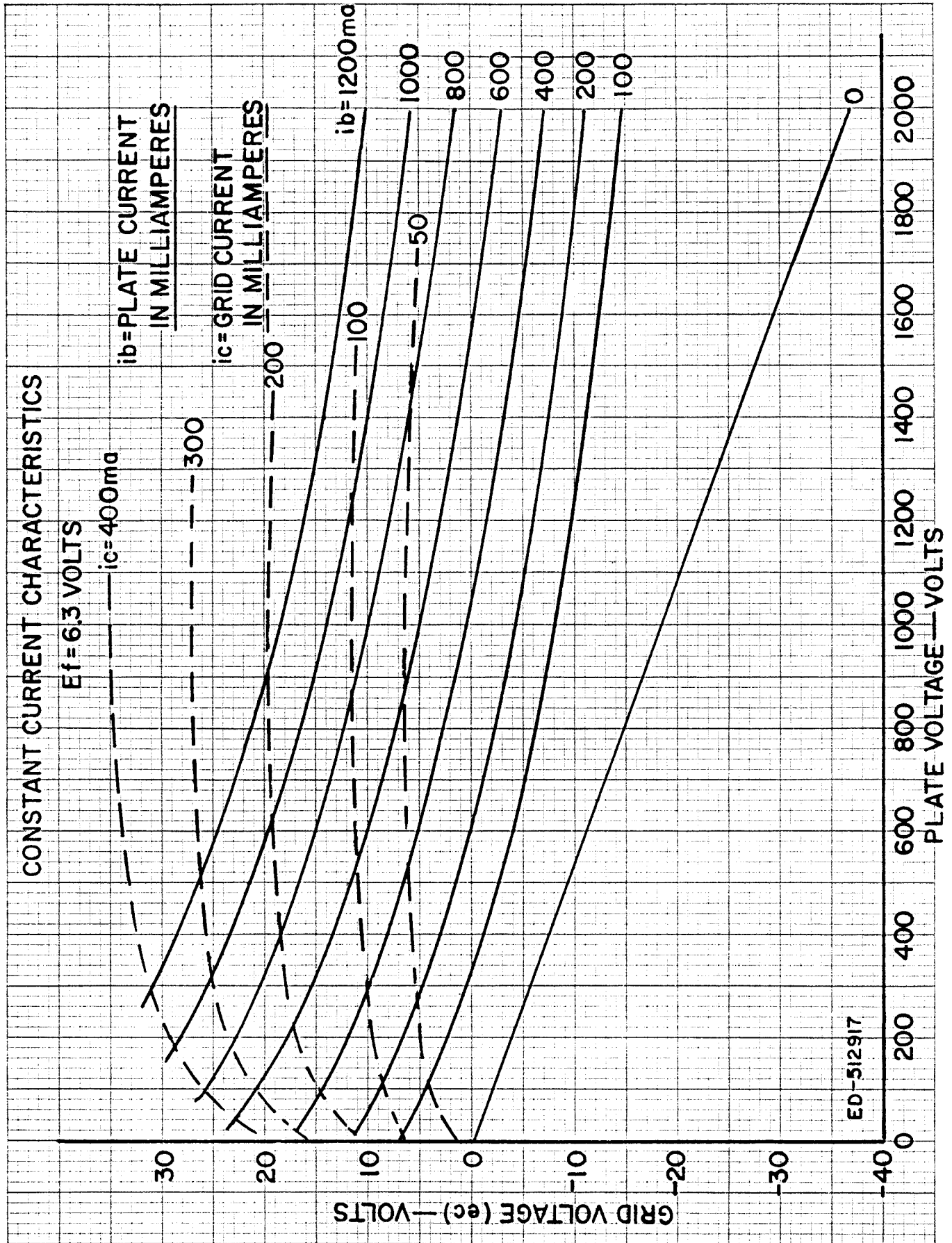

ED-512917

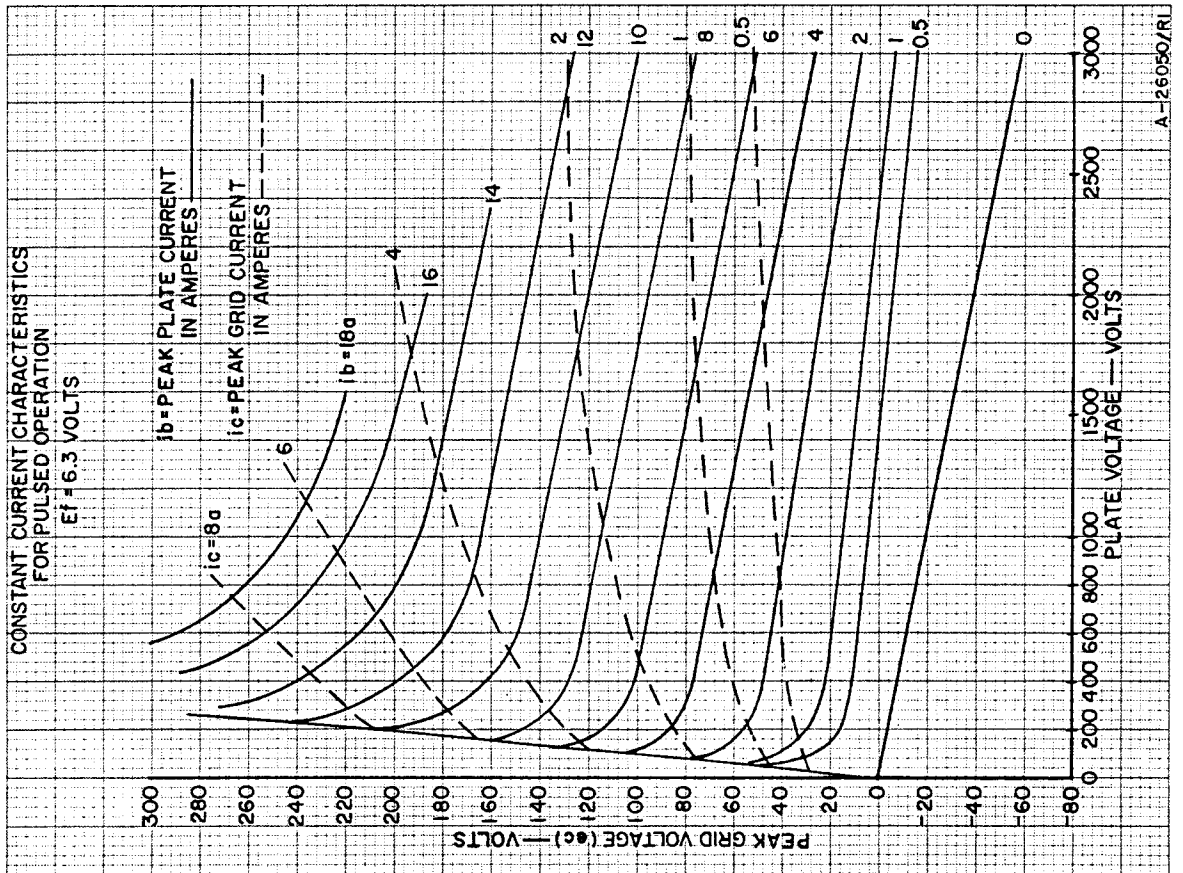
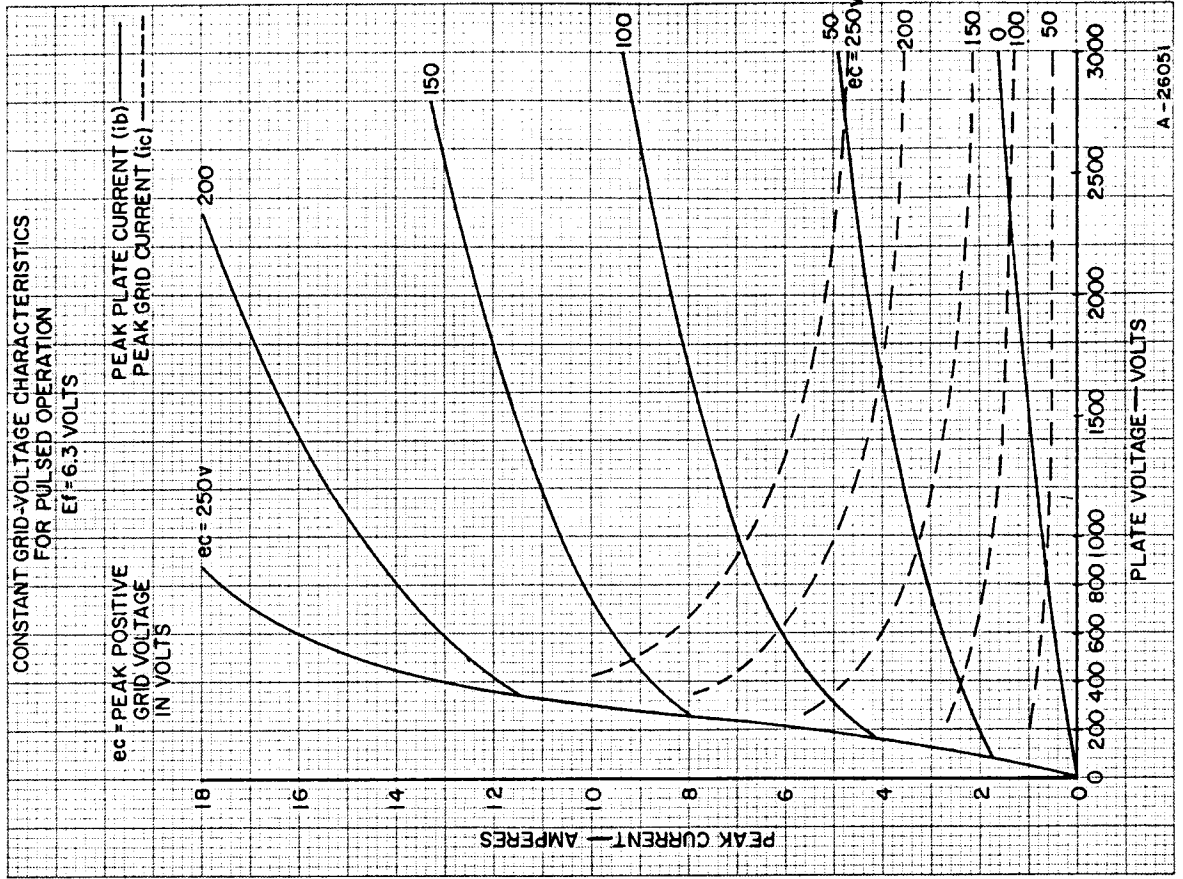

The millimeter dimensions are derived from the original inch dimensions.

Ref	Inches			Millimeters			Notes
	Minimum	Nominal	Maximum	Minimum	Nominal	Maximum	
A	.714		.780	18.14		19.81	
AB	.437	.476	.515	11.10	12.09	13.08	1, 8
AC	.662	.682	.702	16.81	17.32	17.83	1, 10
AD	.605	.645	.685	15.37	16.38	17.40	1, 9
B	.691		.740	17.55		18.80	
C	.570		.607	14.48		15.42	
D	.520		.547	13.21		13.89	
E	.650		.705	16.51		17.91	
F	.400		.415	10.16		10.54	
G	.022		.040	.56		1.02	
I	.192		.208	4.88		5.28	
J	.240		.275	6.10		6.98	
JA	.585		.635	14.86		16.13	
K	.028		.045	.71		1.14	
L	1.235		1.265	31.37		32.13	
M	.565		.580	14.35		14.73	
P	.775		.785	19.68		19.94	
R	.935		.950	23.75		24.13	1, 8
T	.440		.460	11.18		11.68	1, 10
TB			.250			6.35	
TC	.410		.425	10.41		10.80	
U	.595		.607	15.11		15.42	1, 9
W			.313			7.95	
Z			.015			.38	1
ZA	.440		.460	11.18		11.68	

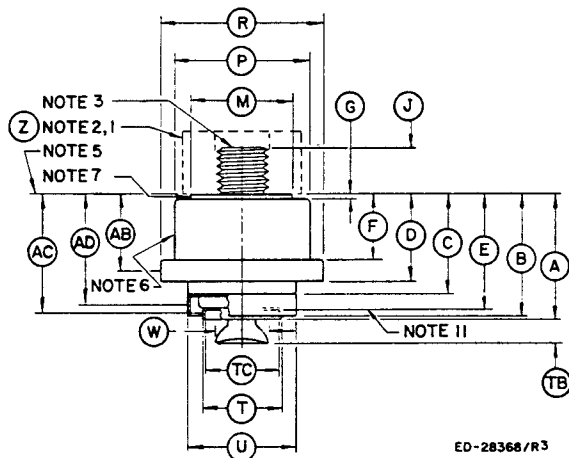
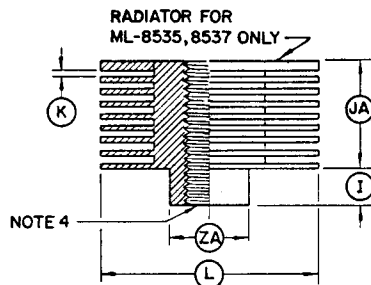

**NOTES:**

1. The total indicated runout of the grid-contact surface (Note 8), the cathode-contact surface (Note 9) and the heater-contact surface (Note 10) will not exceed (Z). This measurement is made with the gage (Note 2) screwed on the anode thread (Note 3) so that the face of the gage makes full contact with the reference surface (Note 5). Runout is then measured with the gage chucked on the measurement reference axis.
2. See outline. Machlett gage No. S-L5. Details will be supplied upon request.
3. See outline. Anode,  $\frac{5}{16}$  — 24 UNF-2A thread.
4. See outline.  $\frac{5}{16}$  — 24 UNF-2B thread. Use  $\frac{5}{16}$ -24 bolt in this hole for tube extraction.
5. See outline. Reference surface. The tube shall be stopped only by this surface when screwed in the socket.
6. See outline. Insulating envelope. Do not clamp or locate on this surface.
7. See outline. Measure anode temperature on this surface.
8. Grid-contact surface and reference dimension for eccentricity measurement, defined by dimensions (R) and (AB).
9. Cathode- or heater-contact surface and reference dimension for eccentricity measurement, defined by dimensions (U) and (AD).
10. Heater-contact surface and reference dimension for eccentricity measurement, defined by dimensions (T) and (AC). See also Note 11.
11. See outline. Alternate heater-contact surface. Heater contact can be made to the bottom of the heater terminal-cup by means of a coil spring having a maximum coil OD of .390 inch and a minimum coil ID of .320 inch, or some similar device.

**RAYTHEON**

**THE MACHLETT LABORATORIES, INC.**

A SUBSIDIARY OF RAYTHEON COMPANY