

TUNG-SOL

TRIPLE-DIODE TRIODE

MINIATURE TYPE

COATED UNIPOTENTIAL CATHODES

HEATER

4.7 VOLTS 0.6 AMP.

AC OR DC

ANY MOUNTING POSITION

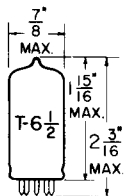

GLASS BULB

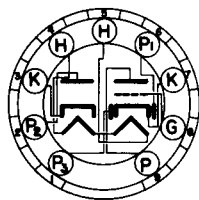

BOTTOM VIEW

MINIATURE GLASS BUTTON
9 PIN BASE

9E

THE 5T8 COMBINES THREE HIGH PERVEANCE DIODES AND A HIGH- μ TRIODE IN ONE ENVELOPE WITH THE 9 PIN MINIATURE CONSTRUCTION AND IS DESIGNED FOR USE IN 600 MA. SERIES HEATER OPERATED RECEIVERS. ONE OF THE THREE DIODE PLATES HAS AN INDEPENDENT CATHODE PROVIDING SATISFACTORY OPERATION IN BALANCED LOW IMPEDANCE DETECTOR CIRCUITS. THIS TUBE STRUCTURE PERMITS THE CONSTRUCTION OF AM/FM RECEIVERS WITH A MINIMUM OF SWITCHING. THERMAL CHARACTERISTICS OF THE HEATER ARE CONTROLLED SUCH THAT HEATER VOLTAGE SURGES DURING THE WARM-UP CYCLE ARE MINIMIZED PROVIDED IT IS USED WITH OTHER TYPES WHICH ARE SIMILARLY CONTROLLED. WITH THE EXCEPTION OF HEATER RATINGS, ITS CHARACTERISTICS ARE IDENTICAL TO THE 6T8.

DIRECT INTERELECTRODE CAPACITANCES

	WITHOUT SHIELD	WITH ^A SHIELD	
TRIODE GRID TO PLATE	1.7	1.7	μ mf
TRIODE INPUT	1.6	1.7	μ mf
TRIODE OUTPUT	1.2	2.4	μ mf
GRID TO ANY DIODE PLATE (MAX.)	.034	.034	μ mf
INPUT DIODE 1	3.8	3.8	μ mf
INPUT DIODE 2	3.8	3.8 ^B	μ mf
INPUT DIODE 3	3.4	3.6	μ mf
DIODE 2 CATHODE TO ALL	7.5	8.5 ^C	μ mf

RATINGS

INTERPRETED ACCORDING TO DESIGN MAXIMUM SYSTEM

HEATER VOLTAGE	4.7	VOLTS
MAXIMUM PLATE VOLTAGE	330 ←	VOLTS
MAXIMUM POSITIVE DC GRID VOLTAGE	0	VOLTS
MAXIMUM PLATE DISSIPATION	1.1 ←	WATTS
MAXIMUM DIODE CURRENT FOR CONTINUOUS OPERATION (EA. PLATE)	5.5 ←	MA.
MAXIMUM HEATER-CATHODE VOLTAGE		
HEATER NEGATIVE WITH RESPECT TO CATHODE:		
TOTAL DC AND PEAK	200	VOLTS
HEATER POSITIVE WITH RESPECT TO CATHODE:		
DC	100	VOLTS
TOTAL DC AND PEAK	200	VOLTS
HEATER WARM-UP TIME (APPROX.)**	11.0	SECONDS

CONTINUED ON FOLLOWING PAGE

TUNG-SOL

CONTINUED FROM PRECEDING PAGE

TYPICAL OPERATING CONDITIONS AND CHARACTERISTICS

CLASS A₁ AMPLIFIER

HEATER VOLTAGE	4.7	4.7	VOLTS
HEATER CURRENT	0.6±6%	0.6±6%	AMP.
PLATE VOLTAGE	100	250	VOLTS
GRID VOLTAGE	-1	-3	VOLTS
AMPLIFICATION FACTOR	70	70	
PLATE RESISTANCE (APPROX.)	54 000	58 000	OHMS
TRANSCONDUCTANCE	1 300	1 200	μMHMS
PLATE CURRENT	0.8	1.0	MA.
AVERAGE DIODE CURRENT: (EACH SECTION) MEASURED WITH 5 VOLTS DC APPLIED		20	MA.

TRIODE UNIT AS RESISTANCE COUPLED AMPLIFIER

PLATE SUPPLY VOLTAGE	90	VOLTS
CONTROL GRID VOLTAGE	0	VOLTS
PLATE LOAD RESISTOR	220 000	OHMS
CONTROL GRID RESISTOR	10.0	MEGOHMS
INPUT CONDENSER	0.01	μf
OUTPUT CONDENSER	0.01	μf
GRID RESISTOR OF FOLLOWING STAGE	470 000	OHMS
SIGNAL SOURCE IMPEDANCE (MAX.)	1 000	OHMS
DISTORTION	5	PERCENT
OUTPUT VOLTAGE	8.5	VOLTS
VOLTAGE GAIN AT 400 CPS	35	

- A WITH EXTERNAL SHIELD #315 CONNECTED TO PIN #7.
- B WITH EXTERNAL SHIELD #315 CONNECTED TO PIN #3.
- C WITH EXTERNAL SHIELD #315 CONNECTED TO PINS #4 AND #5.

** HEATER WARM-UP TIME IS DEFINED AS THE TIME REQUIRED FOR THE VOLTAGE ACROSS THE HEATER TO REACH 80% OF ITS RATED VOLTAGE AFTER APPLYING 4 TIMES RATED HEATER VOLTAGE TO A CIRCUIT CONSISTING OF THE TUBE HEATER, IN SERIES WITH A RESISTANCE OF VALUE 3 TIMES THE NOMINAL HEATER OPERATING RESISTANCE.

→ INDICATES A CHANGE.

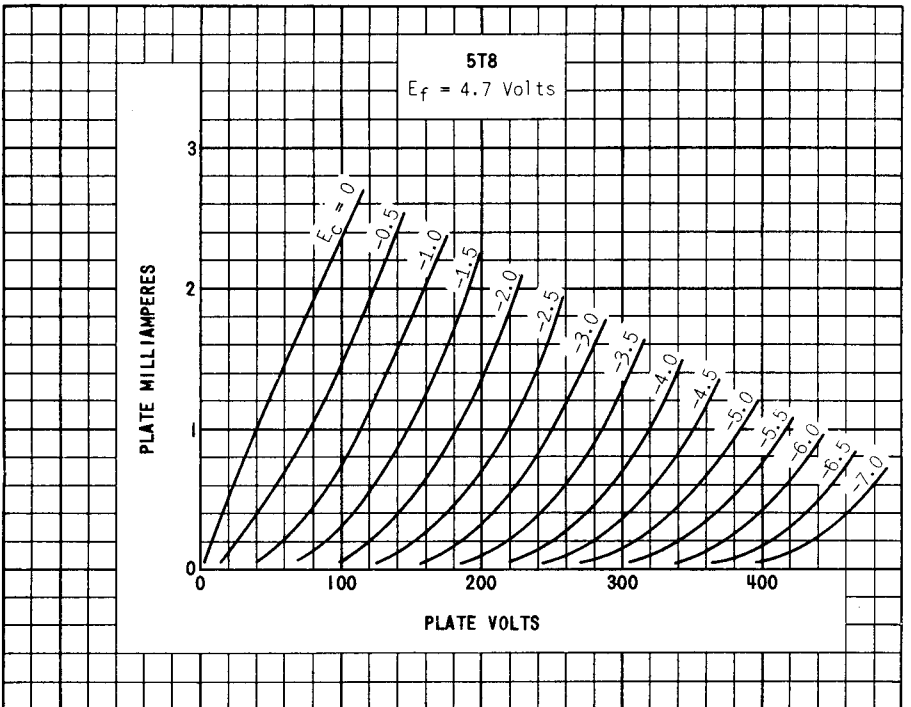
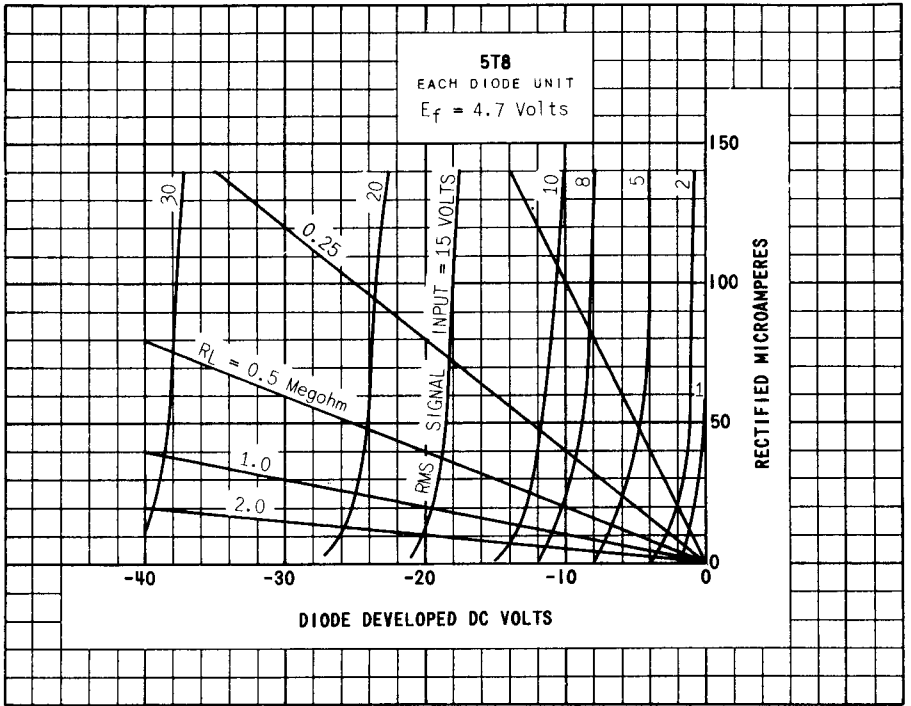

PRINTED IN U. S. A.

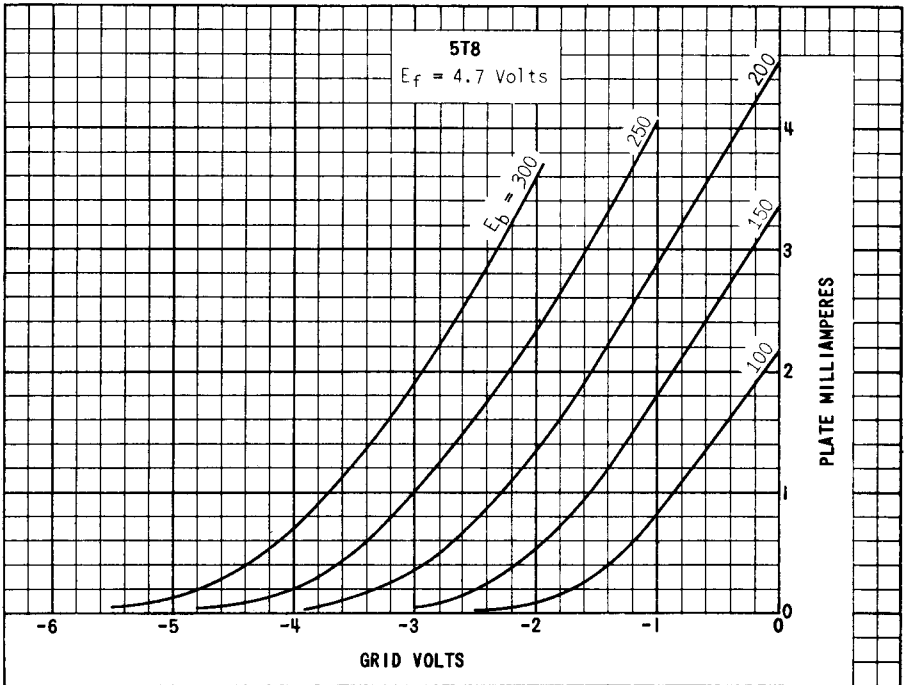
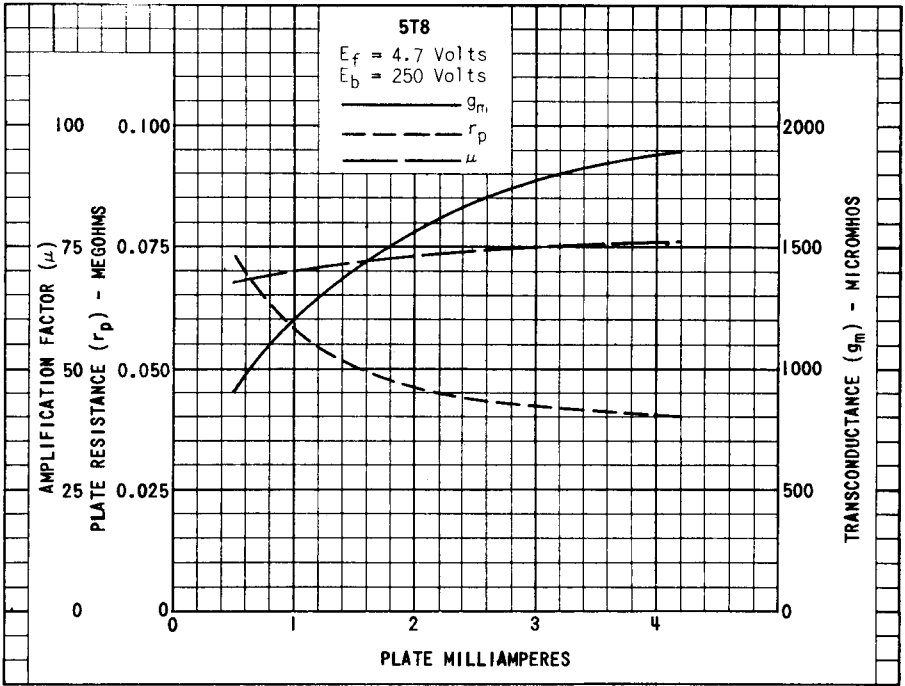

TUNG-SOL

RESISTANCE COUPLED AMPLIFIER

R1 MEG.	Rg1 MEG.	Rc MEG.	E _{bb} = 90 VOLTS			E _{bb} = 180 VOLTS			E _{bb} = 300 VOLTS		
			R _k	GAIN	E _o	R _k	GAIN	E _o	R _k	GAIN	E _o
0.10	A	0.10	5700	21	7	2400	29	18	1800	33	35
0.10	A	0.24	6100	26	9	2700	34	23	2000	38	42
0.24	A	0.24	9100	30	10	4300	40	24	3000	44	43
0.24	A	0.51	10000	34	13	4700	45	31	3300	49	52
0.51	A	0.51	15000	37	14	7500	47	28	5600	51	50
0.51	A	1	16000	40	16	8200	50	35	6200	55	60
0.24	10	0.24	---	31	5.0	---	44	19	---	48	40
0.24	10	0.51	---	37	7.0	---	49	25	---	52	52
0.51	10	0.51	---	39	7.5	---	51	22	---	54	44
0.51	10	1	---	42	10	---	54	28	---	58	56

^A VALUE OF R_{g1} IS NOT CRITICAL.

R_k TAKEN TO NEAREST RMA VALUE FOR EACH CASE INSTEAD OF ABSOLUTE OPTIMUM VALUE.

E_o IS RMS OUTPUT AT 5% TOTAL HARMONIC DISTORTION.

GAIN MEASURED AT E_o = 2.0 VOLTS RMS OUTPUT.

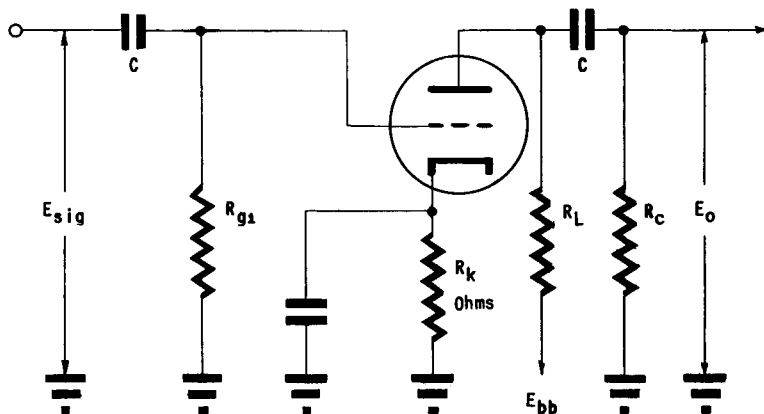

NOTE: COUPLING CAPACITORS (C) SHOULD BE SELECTED TO GIVE DESIRED FREQUENCY RESPONSE. R_k SHOULD BE ADEQUATELY BY-PASSED.