



THOMSON-CSF

GRUPEMENT TUBES ELECTRONIQUES

DATA TEV 3100

TH 9812 PA

October 1971 - Page 1/9

TH 9812 PA 1" VIDICON

- MAGNETIC FOCUS AND DEFLECTION
- HIGH RESOLUTION (900 TV LINES)
- HIGH SENSITIVITY (900 $\mu\text{A}/\text{lm}$ WITH 1 lux ON FACEPLATE)
 - LOW LAG
- INDUSTRIAL TV

TH 9812PA is a 1" Vidicon especially designed for pick-up high quality TV cameras (black and white or color cameras). This tube incorporates in its structure the latest isolated post-acceleration electrode with separate mesh connection. Due to this feature TH 9812PA provides higher resolution, higher output signal capability and better resolution and signal uniformity than previous Vidicon tubes.

TH 9812PA is intended for industrial TV applications, specially for low light level condition : the quality of image is satisfactory for scene illumination of 5 lux (0.5 fc) and even less.

The sensitivity of TH 9812PA can be equivalent to photographic film having an ASA exposure index of 2000 (34/10 DIN, 41 Sch). Satisfactory quality picture with good resolution and acceptable signal to noise ratio can be obtained at illumination of 0.3 lux (30 mfc) on the faceplate (3 to 6 lux on the subject with an unity numerical aperture lens) giving rise to a signal current of 50 nA at 50 nA dark current. For such illuminations, higher signal current is obtained by increasing dark current up to 100 nA value beyond which a signal saturation will occur.

Due to a new low lag photoconductive layer excellent quality of picture can be obtained within a large illumination range with good signal uniformity and appropriate "gamma" characteristics.

TH 9812PA performances are substantially identical under high or low level illumination conditions. Tube sensitivity can be controlled by target voltage which also causes some variation of dark current.

TH 9812PA can be operated over a wide range of electrode voltage selection although recommended adjustment requires a g4 voltage to g3 voltage ratio of 1.4 - 1.5. Under these conditions TH 9812PA can provide an optimum resolution and a uniform signal output over the entire scanned area with a beam landing considerably improved minimizing "porthole" effect and geometrical distortion.

The limiting resolution of TH 9812PA at the center of the picture is about 1000 T.V. lines and about 600 T.V. lines at the corner. This high resolution is obtained with electrode g4 voltage of 900 V and electrode g3 voltage of 600 V. When TH 9812PA is operated at a lower g4 voltage of 500 V and a g3 voltage of 300 to 350 V, its resolution will be about 900 T.V. lines at the center and 500 T.V. lines at the corner. Operating g4 voltage at 1.5 times g3 voltage requires a 20 % deflection current increase over current necessary for g3 - g4 connected electrodes mode. Focusing field is not noticeably changed with such an operation.

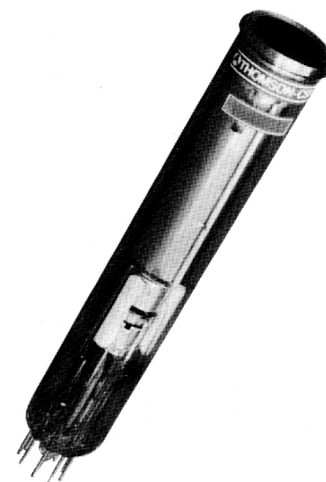



Full advantage of resolution and signal uniformity is achieved when deflecting and focusing components are properly designed and when the tube is correctly located inside. The thickness of the photoconductive layer is made very uniform and allows for constant output signal and constant dark current. When landing error due to imperfect scanning system is present, the voltage gradient across the photoconductive layer is not uniform and a signal variation (shading) is introduced which can be compensated by proper adjustment of the cathode, g1 and g2 voltages.

Due to good design, high reliability is obtained throughout the tube life. Requirement for alignment field is reduced to a minimum by precise electron gun mounting. An extremely flat faceplate avoids all optical distortions and allows for the use of any good quality lens. Particle barriers adjacent to the field mesh allows these tubes to operate in any position.

One watt power heater makes these Vidicons particularly suitable for transistorized equipment. The reduced heat dissipation improves the quality of the picture by lowering faceplate temperature.

GENERAL CHARACTERISTICS

Electrical

Heater	for unipotential cathode indirectly heated
Heater :	
voltage	6.3 ± 10 % V
current at 6.3 V	0.15 A
Minimum preheating time	60 s
Output capacitances :	
target to all other electrodes	4.5 pF
Spectral response	see curve
Focusing method	magnetic
Deflection method	magnetic

Mechanical

Base (Ditetrar, 8 pins)	UTE 9 C 15 (JEDEC N° E8 - 11) METOX N° 30.250
Socket (note 1)	GERHARD type BV 200 1K 1 or equivalent
Deflecting yoke - focusing coil assembly (note 2)	GERHARD type BV 80/3 or equivalent
Alignment coil (note 2)	CLEVELAND VYFA - 355 - 2 or equivalent
Deflection - focus - alignment assembly (note 2)	see drawing
Dimensions	
Photoconductive layer :	
normal dimensions of image on target	12.7 mm x 9.5 mm
maximum useful diagonal diameter (4 x 3 aspect ratio)	17 mm
orientation of quality rectangle :	
horizontal scan parallel to the plane passing through the tube axis and short index pin (note 3)	
Maximum temperature of faceplate	70 °C
Mounting position	any
Net weight, approximate	60 g



OPERATING CONDITIONS

SCANNED AREA 12.7 mm x 9.5 mm

Maximum ratings (Absolute values)

Electrode g4 voltage (post acceleration electrode)	1000	V
Electrode g3 voltage (wall electrode)	1000	V
Electrode g2 voltage (accelerator)	350	V
Electrode g1 voltage (electrode for picture cut-off) :		
negative bias value	150	V
positive bias value	0	V
Peak heater cathode voltage :		
heater negative with respect to cathode	125	V
heater positive with respect to cathode	10	V
Target voltage	125	V
Dark current	0.20	μA
Peak target current (note 4)	0.60	μA
Faceplate :		
illumination	10000	lux
	or 1000	fc
temperature	70	°C

Typical operation

SCANNED AREA 12.7 x 9.5 mm
FACEPLATE TEMPERATURE 25 °C (note 5)

Electrode voltage modes :	Low	Intermediate	High	
Electrode g4 voltage	300	500	900	V
Electrode g3 voltage	180	300 to 350	600	V
Electrode g2 voltage	300	300	300	V
Electrode g1 (note 6)	-45 to -110	-45 to -110	-45 to -110	V
Average "gamma" for a target illumination between 1 and 100 lux (note 7)	0.65	0.65	0.65	
Minimum blanking peak to peak voltage :				
applied to electrode g1	-75	-75	-75	V
applied to cathode	+20	+20	+20	V
Limiting resolution at center of picture — (note 8)	800	900	1000	TV lines
Limiting resolution at corner of picture	400	500	600	TV lines
M.T.F. response at 400 T.V. lines at center of picture (5 MHz - 625 CCIR standard) (note 9)	30	40	50	%
Field strength at center of focusing coil	30 ± 2	40 ± 2	50 ± 2	Gauss
Peak deflecting coil current :				
horizontal	130	170	200	mA
vertical	15	20	24	mA
Field strength of alignment coil	0 to 4	0 to 4	0 to 4	Gauss



1 - HIGH LIGHT LEVEL OPERATION

(faceplate illumination 100 lux or 10 fc)

Dark current i_0	5	nA
Target voltage for $i_0 = 5$ nA (note 10)	10 to 25	V
Faceplate illumination (2854 °K) (note 11)	100	lux
	or 10	fc
Signal current	350	nA
Lag : (note 12)		
- maximum	15	%
- average	10	%

2 - AVERAGE SENSITIVITY OPERATION

(faceplate illumination 10 lux or 1 fc)

Dark current i_0	20	nA
Target voltage for $i_0 = 20$ nA (note 10)	20 to 50	V
Faceplate illumination (2854 °K) (note 11)	10	lux
	or 1	fc
Signal current	250	nA
Corresponding sensitivity	200	μ A/lm
Target illumination for 100 nA signal current	1.5	lux
	or 150	mfc
Lag : (note 12)		
- maximum	20	%
- average	12	%

3 - HIGH SENSITIVITY OPERATION

(faceplate illumination 1 lux or 100 mfc)

Dark current i_0	50	nA
Target voltage for $i_0 = 50$ nA (note 10)	25 to 60	V
Faceplate illumination (2854 °K) (note 11)	1	lux
	or 100	mfc
Signal current	110	nA
Corresponding sensitivity	900	μ A/lm
Target illumination for 100 nA signal current	0.8	lux
	or 80	mfc
Lag : (note 12)		
- maximum	20	%
- average	15	%

4 - VERY HIGH SENSITIVITY OPERATION

(faceplate illumination 0.5 lux or 50 mfc)

Dark current i_0	100	nA
Target voltage for $i_0 = 100$ nA (note 10)	30 to 70	V
Faceplate illumination (2854 °K) (note 11)	0.5	lux
	or 50	mfc
Signal current	100	nA
Corresponding sensitivity	1500	μ A/lm
Target illumination for 50 nA signal current	0.1	lux
	or 10	mfc
Lag : (note 12)		
- maximum	20	%
- average	17	%



5 - SPURIOUS SIGNAL TEST

The test is performed using a uniformly diffused white test pattern that is separated into two zones as shown in drawing.

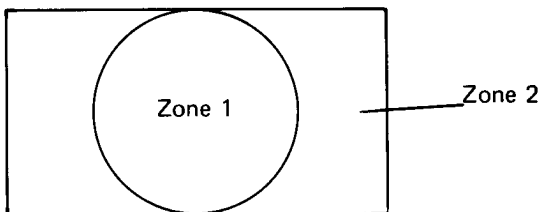

The tube is operated under the "Typical operation" condition with a dark current of 20 nanoampères and the lens adjusted to provide a signal current of 200 nanoampères.

Spurious signals are classified by their size, which is measured in percent of raster height

Will actually be considered as defects, spot blemishes (black or white spots) of 30 % minimal contrast (note 13).

Allowable spot size for each zone is shown in table :

Ratio D/H* (Percent raster height)	Number allowed	
	Zone 1	Zone 2
$D/H > 1 \%$	0	0
$0.8 < D/H \leq 1 \%$	0	2
$0.5 \leq D/H \leq 0.8 \%$	2	4
$D/H < 0.5 \%$	3	allowed
Total spots	6	

Spot blemishes with contrast less than 30 % :

- if $D/H \leq 1 \%$, are allowed
- if $D/H \leq 2 \%$, five defects are allowed.

* *D* : average diameter of spot *H* : raster height

Smudges, streaks, mottled or grainy background having a contrast ratio less than 15 % are allowed.



NOTES

- 1** – METOX - 86, rue de Villiers de l'isle Adam - PARIS 20ème
Téléphone : 636 - 31 - 10
- 2** – GERHARD KG - REICHELSEIM / ODW Germany
CLEVELAND ELECTRONICS INC. 2000 Highland Road - TWINSBURG - OHIO 44 087.
- 3** – It is necessary to assure correct positioning of the tube inside the coils. An immediate test consists in observing the fine mesh grid, the wires of which should be inclined 45 ° with respect to scanning. Then again the front end of the deflecting yoke should be positioned at 20 mm from the tube faceplate.
- 4** – Target current is defined as total current in load resistance connected to target electrode : signal current plus dark current, dark current being the current left when illumination is subtracted.
Video amplifiers must be designed properly to handle peak target current of 0.7 μ A to avoid amplifier overload and picture distortion.
- 5** – All these characteristics are provided for a temperature of faceplate of 25 °C, the temperature range recommended is within 20 to 30 °C. The rise of faceplate temperature is a function of ambient temperature, thermic dissipation of ambient devices and of the tube itself. Consequently, 10 °C of faceplate temperature rise implies a dark current multiplied by a factor of 2.
- 6** – Without blanking pulses applied on electrode g1.
- 7** – Average "gamma" should be defined as the slope of the rectilinear part of transfer characteristics in log coordinates.
- 8** – Practically, limiting resolution corresponds to the resolution measured with twin bar test card with a modulation ratio of about 7 %.
- 9** – For 625 lines C.C.I.R. standard, line duration being 52 μ s (line suppression period not included), 400 TV lines correspond to 5 MHz.
- 10** – Indicated range of each type of service serves only to illustrate the operating target voltage range normally encountered. The target voltage for each Vidicon must be adjusted to that value which gives the designed operating dark current.
- 11** – All the above mentioned illumination assume 2854 °K incandescent tungsten source.
- 12** – Lag is defined as the ratio of residual signal current measured 60 milliseconds after light excitation being removed to the initial signal current ; this value assumes 50 field/second scanning rate.
- 13** – Contrast is defined as :

$$100 \times \frac{\text{increment in video current due to the blemish}}{\text{normal signal current}}$$



Figure 1

TYPICAL SPECTRAL SENSITIVITY CHARACTERISTICS

For equal values of signal current at all wavelengths
(0.02 μA signal current and 0.02 μA dark current
for scanned area of 12.7 x 9.5 mm)

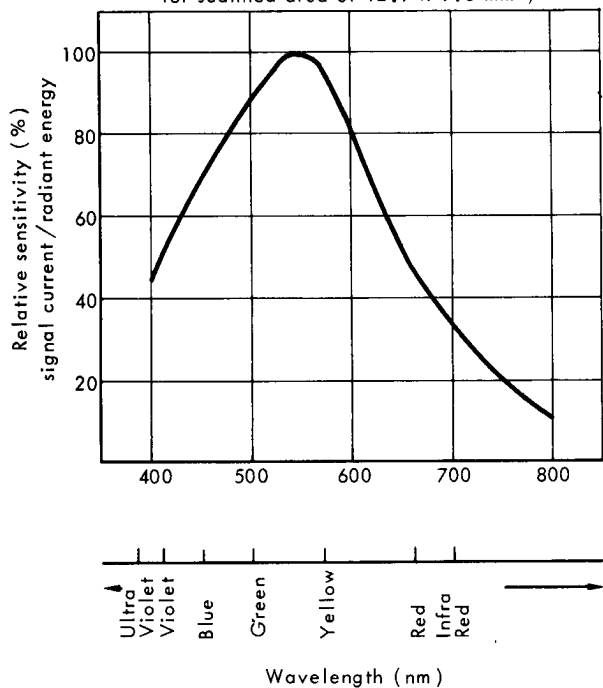

Figure 2

LIGHT TRANSFER CHARACTERISTICS

Illumination uniform over photoconductive layer scanned
area 12.7 x 9.5 mm-face plate temperature 25°C

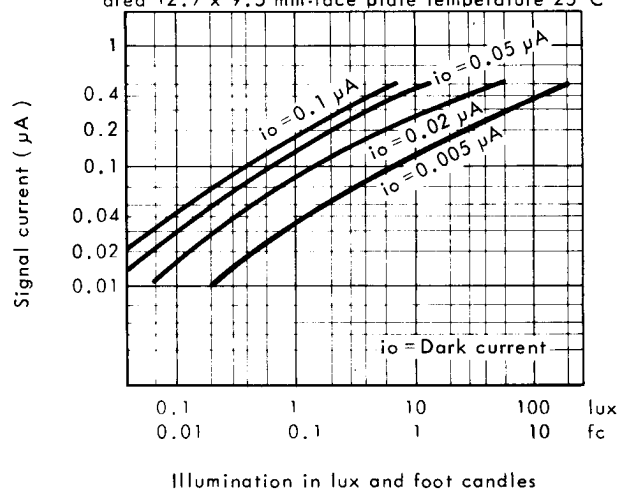

Figure 3

MODULATION TRANSFER FUNCTION

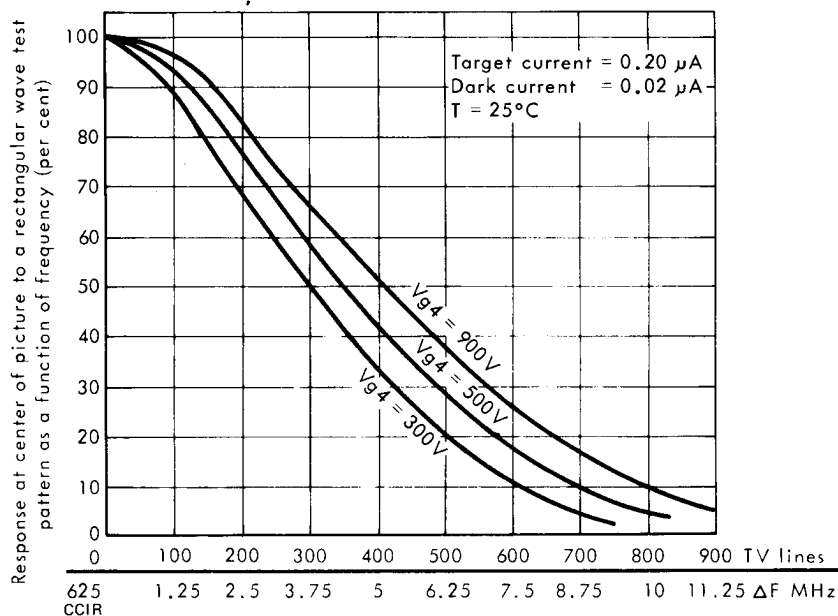



Figure 4

RANGE OF DARK CURRENT
Scanned area of photoconductive layer 12.7 mm x 9.5 mm

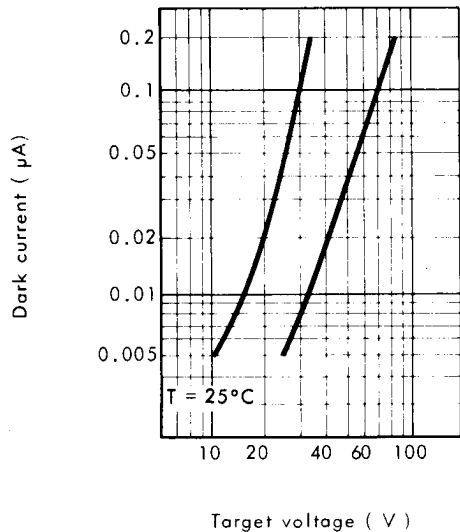

Figure 5

TYPICAL PERSISTENCE CHARACTERISTICS
Initial highlight signal current of 0.2 μA scanned area of photoconductive layer 12.7 x 9.5 mm

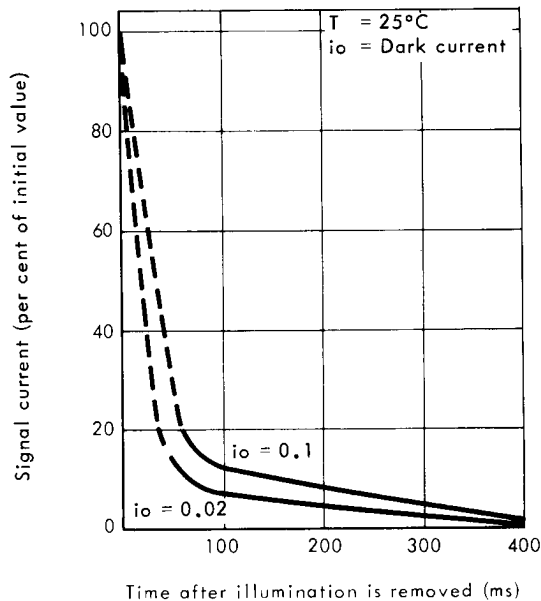
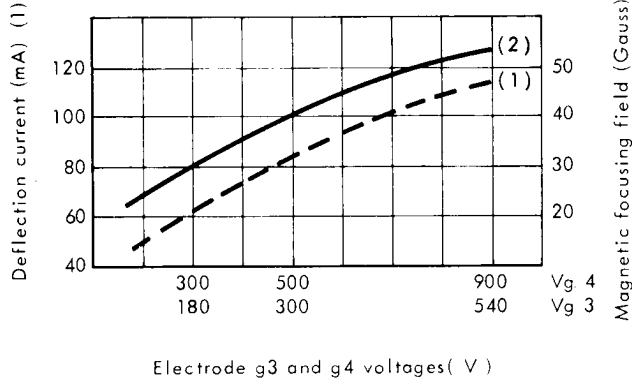

Figure 6

- (1) Deflection current as a function of electrode g3 and g4 voltages ($V_{g3} = 0.6 V_{g4}$)
- (2) Magnetic field at center of focusing coil ($V_{g3} = 0.6 V_{g4}$)

Scanned area of photoconductive layer 12.7 mm x 9.5 mm





OUTLINE DRAWING

UTE 9C15 base
(JEDEC E8-11)

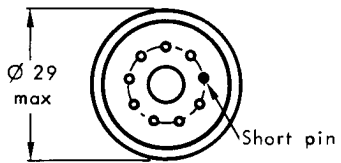

BASING DIAGRAM

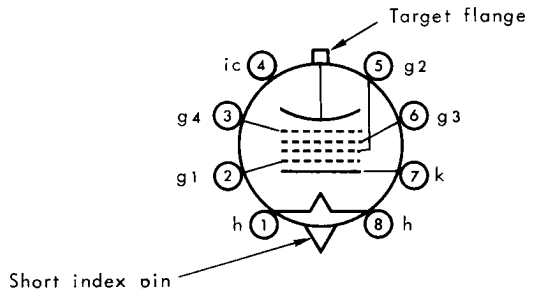

1 - Heater	5 - Electrode g2
2 - Electrode g1	6 - Electrode g3
3 - Electrode g4	7 - Cathode
4 - Internal connection	8 - Heater

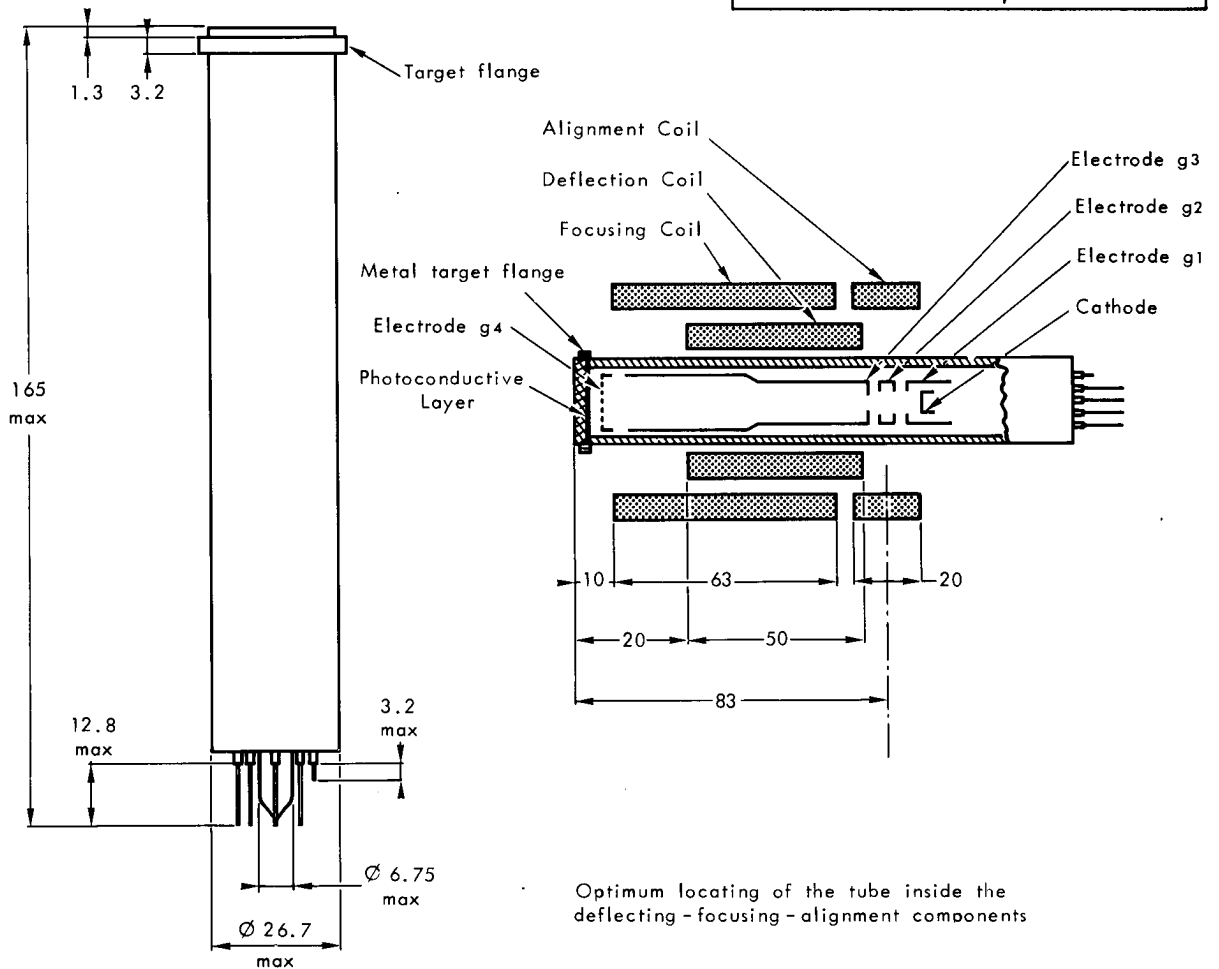

Dimensions in mm.

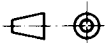



THOMSON-CSF
GROUPEMENT TUBES ELECTRONIQUES



THOMSON-CSF